

LEXON®

WORKBOOK H1 2026



+35 years *of good design*
+35 ans *de good design*

1991-2026

2025 awards



LEXON®
1991
 LEXON is founded in Paris, France
LEXON est créée à Paris, France

MoMA
1999
 Tykho radio is selected among MoMA's museum permanent collection
La radio Tykho rejoint la collection permanente du MoMA

2000
 LEXON is the first object editor to make the cover of Time Magazine
LEXON est le premier éditeur d'objets à faire la couverture du Time Magazine

BOW GROUP
2018
 BOW Group acquires LEXON
Le Groupe BOW fait l'acquisition de LEXON

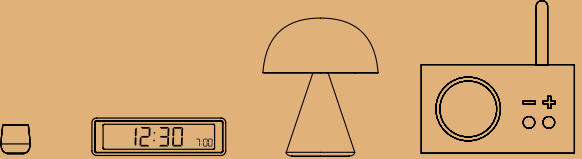

2025
 Lexon has won 5 iF and 7 Red Dot Design Awards in 2025
LEXON bat son record en remportant 5 iF & 7 Red Dot Design Awards

2026
 LEXON partners with Jeff Koons to introduce an exclusive collaboration
LEXON s'associe à Jeff Koons autour d'une collab exclusive

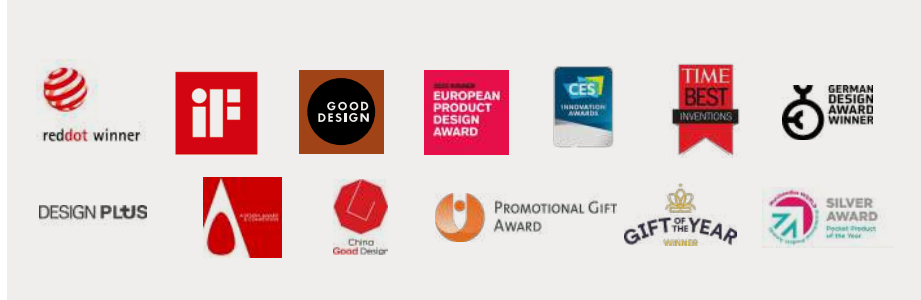

**EACH OF OUR ICONIC PRODUCTS HAS BEEN SOLD AT
 CHACUN DE NOS PRODUITS ICONIQUES A ÉTÉ VENDU À DES
 MILLIONS
 OF PIECES / DE PIÈCES**

**+250 INTERNATIONAL AWARDS
 RÉCOMPENSES INTERNATIONALES**





Environmental
responsibility

Our commitment to sustainability *includes several missions:*

MATERIALS

Our goal is to build durable Lexon products made from recycled and low-impact materials. Our Procurement team is committed to embracing circularity with our key suppliers in all aspects of product design. Whenever possible, we prioritize the use of materials with low or neutral carbon footprint.

- To date, over 70% of our products are partially or entirely made of aluminum, a highly recyclable material.
- Products containing ABS or polycarbonate are in the process of transitioning to recycled plastics or those containing already recycled elements.
- The synthetic leathers used are already environmentally friendly and vegan

PACKAGINGS

All our new products are now protected by 100% recyclable molded cardboard cases, and the use of plastic is limited to 100% recyclable PET. The transition to these new packaging designs for the entire range has now been completed in 2024.

PRODUCTS WITH POSITIVE IMPACT

Part of our responsibility is to help consumers make better choices and adopt eco-conscious habits. We introduce impactful items such as reusable bottles, metal straws, and reusable cutlery to assist them in doing so. At the core of our strategic planning, we prioritize creating products with a long life cycle, eliminating the need for frequent renewal.

TRANSPORT

We have shifted to less polluting transportation methods, primarily shipping our products by sea rather than air. This optimization of containers in terms of size and points ensures more efficient and effective transportation.

LEXON[®]

Meet the designers



QUAGLIO & SIMONELLI

Quaglio Simonelli was born from the meeting of two Italian designers: Andrea Quaglio and Manuela Simonelli. The result of the meeting between two complementary sensibilities, their products have been nourished by their history, by the creative gaze they direct on the world that surrounds them and by the mutation they love to induce on it. They design objects with a familiar appearance, contaminated by unexpected and poetic elements. Best-selling products designed for Lexon include: Mino, Mina, Luma collection, Oblio and more recently Mano, Minut, Mimi, Steli & Nova collection.

Quaglio Simonelli est né de la rencontre de deux designers italiens : Andrea Quaglio et Manuela Simonelli. Fruit de l'union de deux sensibilités complémentaires, leurs créations sont nourries par leur histoire, par le regard créatif qu'ils portent sur le monde qui les entoure et par les transformations qu'ils aiment y insuffler. Ils conçoivent des objets à l'apparence familière, enrichis d'éléments inattendus et poétiques. Parmi les produits best-sellers qu'ils ont imaginés pour Lexon figurent : Mino, Mina, la collection Luma, Oblio et, plus récemment, Mano, Minut, Mimi et la collection Steli & Nova.



A la rencontre de nos designers



MARC BERTHIER

French Designer and Industrial Architect, Marc Berthier's career spans more than 55 years. His creations are present in the collections of many museums, including the Museum of Modern Art (MoMA) in New York, the Center Georges Pompidou and the Museum of Decorative Arts in Paris, the Cooper Hewitt and the Smithsonian design museum in New York. York, the Plasticarium ADAM in Brussels... Marc Berthier imagined our Tykko radio, an iconic and timeless object that made the cover of Time magazine in 2000.

Designer français et architecte industriel, Marc Berthier a mené une carrière de plus de 55 ans. Ses créations sont présentes dans les collections de nombreux musées, notamment le Museum of Modern Art (MoMA) à New York, le Centre Georges Pompidou et le Musée des Arts Décoratifs à Paris, le Cooper Hewitt et le Smithsonian Design Museum à New York, ainsi que le Plasticarium ADAM à Bruxelles... Marc Berthier a imaginé notre radio Tykko, un objet iconique et intemporel qui a fait la couverture du magazine Time en 2000.



ALAIN BERTEAU

Alain Berteau is a Brussels-based architect, product designer and professor. Alain's work is recognized for its combined simplicity and decisive functional innovation. Best-selling products designed for Lexon include the Softpower collection.

Alain Berteau est un architecte, designer produit et professeur basé à Bruxelles. Son travail est reconnu pour sa simplicité alliée à une innovation fonctionnelle déterminante. Parmi les best-sellers qu'il a conçus pour Lexon figure la collection Softpower.



Meet the designers



NEIL POULTON

Based in France since 1992, neil poulton is globally recognized for his work on consumer electronics products and lighting equipment. His trademarks are minimalist forms for everyday use, blending simple look and technical innovation. Together with Lexon, neil is reinventing daily objects by embedding high quality performance into iconic shapes.

Installé en France depuis 1992, Neil Poulton est reconnu mondialement pour son travail sur les produits d'électronique grand public et les équipements d'éclairage. Ses signatures sont des formes minimalistes conçues pour un usage quotidien, alliant simplicité visuelle et innovation technique. En collaboration avec Lexon, Neil réinvente les objets du quotidien en intégrant des performances de haute qualité dans des formes iconiques.



A la rencontre de nos designers



NATACHA POUTOUX & SACHA HOURCADE

natacha.sacha. is a duo of talented French designers with a large set of skills. Their experiences in furniture, architecture and attention to sustainability is providing uncompromised complementary to all objects of the distinctive Horizon collection.

natacha.sacha. est un duo de designers français talentueux aux compétences multiples. Leur expérience dans le mobilier, l'architecture et leur attention portée à la durabilité apportent une complémentarité sans compromis à l'ensemble des objets de la collection Horizon, reconnaissable entre toutes.

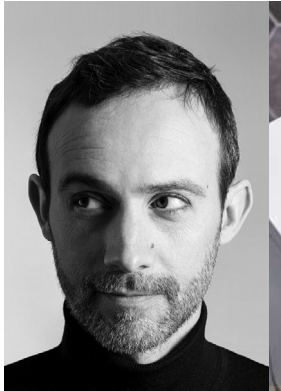

GUILLAUME DELVIGNE

Guillaume started with prestigious designers like George Sowden and Marc Newson. He went solo, collaborating with both industrialists and craftsmen. From his meeting with Lexon comes the Nomaday collection, combining purity of lines and innovation.

Guillaume a débuté auprès de designers prestigieux tels que George Sowden et Marc Newson. Il s'est ensuite lancé en solo, collaborant aussi bien avec des industriels qu'avec des artisans. De sa rencontre avec Lexon est née la collection Nomaday, qui allie pureté des lignes et innovation.



NELSON FOSSEY

Nelson Fossey imagines concepts where technology is at the core of user experience. His collaboration with Lexon makes it possible to offer products with an apparent simplicity, a playful character and remarkable ease of use. His first creation for Lexon: Orbe.

Nelson Fossey imagine des concepts où la technologie est au cœur de l'expérience utilisateur. Sa collaboration avec Lexon permet de proposer des produits d'une simplicité apparente, dotés d'un caractère ludique et d'une remarquable facilité d'utilisation. Sa première création pour Lexon : Orbe.



Meet the designers



LIDIA GOMEZ

Lidia Gómez is a talented Spanish Industrial Designer recognized for her sharp and minimalist approach to design. Her tech background has facilitated the collaboration with Lexon to develop surprising, yet consumer-friendly objects with the perfect balance of aesthetics and function.

Lidia Gómez est une talentueuse designer industrielle espagnole, reconnue pour son approche du design à la fois précise et minimaliste. Son parcours dans la tech a facilité sa collaboration avec Lexon pour développer des objets étonnants, mais faciles à utiliser, offrant un parfait équilibre entre esthétique et fonctionnalité.



A la rencontre de nos designers



STEFANIE KAY

Stéfanie Kay is a French & British young designer from ECAL, the renowned Swiss school of art & design. Her work has already been honored with several awards and her collaboration with Lexon is bringing sleek consumer objects to the market with a special focus on user experience and value-added features.

Stéfanie Kay est une jeune designer franco-britannique issue de l'ECAL, la célèbre école suisse d'art et de design. Son travail a déjà été récompensé par plusieurs prix et sa collaboration avec Lexon permet de proposer au marché des objets grand public élégants, avec un accent particulier mis sur l'expérience utilisateur et les fonctionnalités à forte valeur ajoutée.

ADRIAN & JEREMY WRIGHT

The British brothers have a background in engineering and a solid understanding of the manufacturing process. Their approach is driven by a desire to reconsider and simplify how objects look and function. Best-selling products designed for Lexon include the Flip collection.

Les frères britanniques ont une formation en ingénierie et une solide compréhension des processus de fabrication. Leur approche est guidée par la volonté de repenser et de simplifier l'apparence et le fonctionnement des objets. Parmi les best-sellers qu'ils ont conçus pour Lexon figure la collection Flip.



LEXON®

*As well as other designers with whom Lexon had the pleasure to collaborate with, including:
Ainsi que d'autres designers avec qui Lexon a eu le plaisir de collaborer, parmi lesquels :*

Philippe Starck, Pauline Deltour,
Shoji Ito, Ionna Vautrin, Mathieu Lehanneur, Eugeni Quitllet,
Elise Berthier & Anne Klepper, José Lévy,
Marc Venot, Theo Williams and Claudio Gatto.

Lexon Colorama



Colorama Lexon



TODAY

A global retail expansion strengthened with the opening of new branded locations.

Renforcement de notre présence à l'international notamment grâce à l'ouverture de nouveaux espaces de vente.



9,000

Point of sales
Points de vente



90

Countries
Pays



LEXON, ALL DAY LONG

LEXON, TOUT AU LONG DE LA JOURNÉE

At LEXON, we create design objects that are meant to be part of your daily life, from morning till night. For that reason, we have rethought the way we define product categories and taken a transversal approach to better reflect how our objects fit your lifestyle. *Chez LEXON, nous créons des objets design qui vous accompagnent au quotidien, du matin jusqu'au soir. Pour cette raison, nous avons repensé la façon dont nous définissons nos catégories produits et adopté une approche transversale pour mieux refléter la façon dont nos objets s'adaptent à votre style de vie.*

COLLABS COLLABORATIONS



JEFF KOONS

PANTONE™



Keith Haring

JEAN-MICHEL BASQUIAT

PRODUCT CATEGORIES CATEGORIES PRODUIT



ALARM CLOCKS
RÉVEILS



AUDIO
AUDIO



LAMPS
LAMPES



WELLNESS
BIEN-ÊTRE

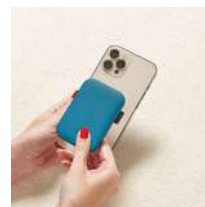

CHARGERS
CHARGEURS



OFFICE
BUREAU



ACCESSORIES
ACCESSOIRES



BAGS
SACS

JEFF KOONS



PANTONE™



COLLABORATIONS

Keith Haring

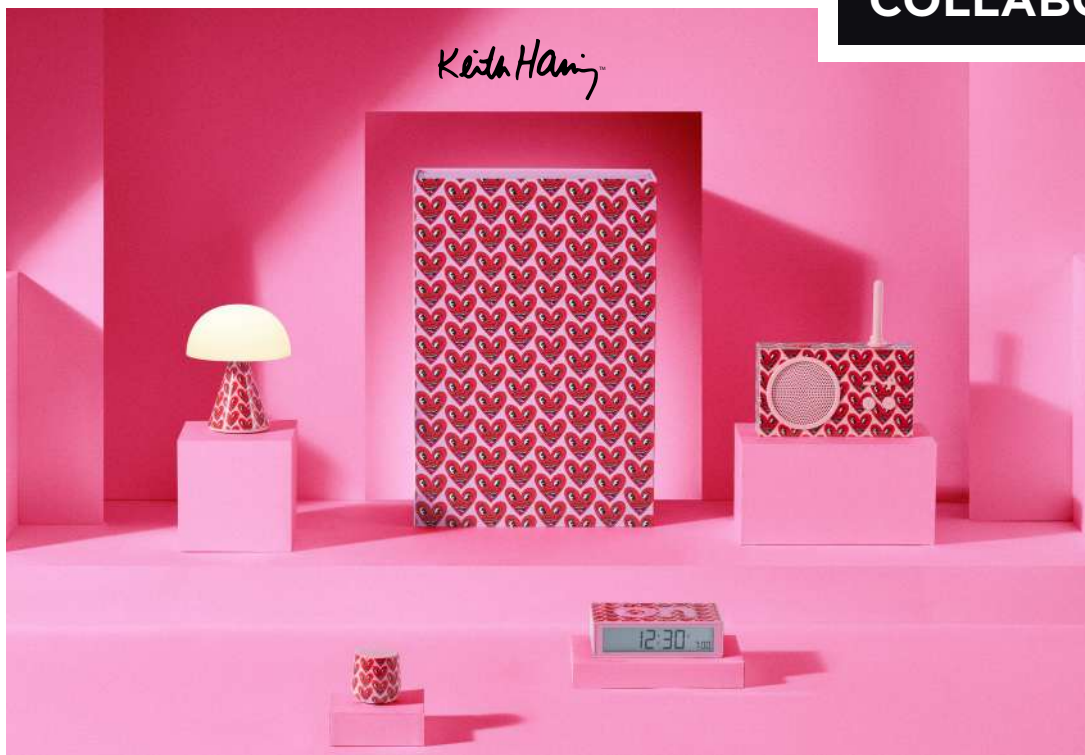

JEAN-MICHEL BASQUIAT.

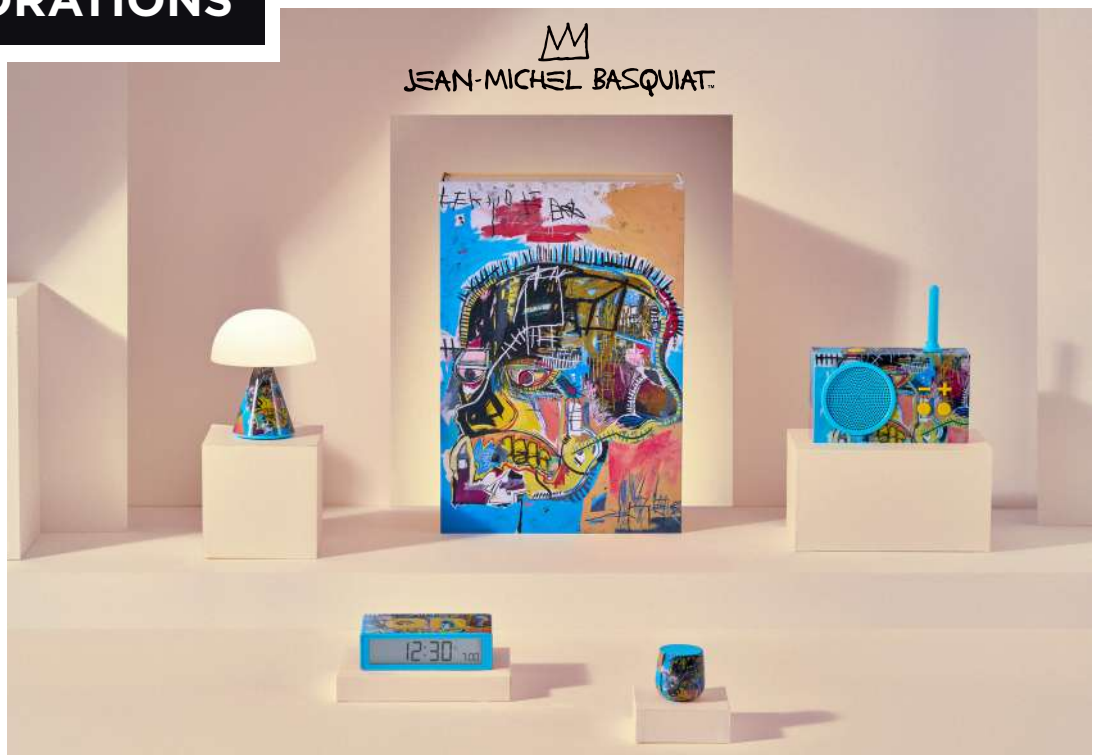

LEXON® × JEFF KOONS



RATED 5 STARS BY COLLECTORS AROUND THE WORLD
NOTÉ 5 ÉTOILES PAR DES COLLECTIONNEURS DU MONDE ENTIER

BALLOON DOG LAMP

The Balloon Dog Lamp harnesses advanced multicolor lighting through nearly 400 integrated LEDs, delivering up to 200 lumens. It offers a wide selection of hues including warm and cold white, blue, magenta, green, orange, and more, allowing users to tailor the lighting to any setting. More than illumination, it offers a dynamic play of light, empowering users to shape the atmosphere and mood of any space with precision and elegance

Le Balloon Dog Lamp dispose d'un éclairage multicolore avancé avec près de 400 LED intégrées, fournissant jusqu'à 200 lumens. Il propose un large choix de couleurs, dont le blanc chaud et le blanc froid, ainsi que bleu, magenta, vert, orange, et plus encore, permettant aux utilisateurs d'adapter la lumière à tout environnement. Plus qu'un simple éclairage, il offre un jeu lumineux dynamique, donnant aux utilisateurs le pouvoir de modeler l'ambiance et l'atmosphère avec précision et élégance.



BALLOON DOG SPEAKER

Conceived as a true acoustic art piece equipped with Bluetooth 5.0 technology, the Balloon Dog speaker delivers 360° high-fidelity sound with exceptional richness and depth. Its enveloping soundscape is born from the harmonious alliance of six ultra-precise active drivers and four finely tuned passive radiators, meticulously crafted to elevate the low frequencies.

Pensé comme un véritable objet d'art acoustique, équipé de la technologie Bluetooth 5.0, le Balloon Dog Speaker est une enceinte qui diffuse un son haute fidélité à 360°, d'une richesse et d'une profondeur exceptionnelles. Sa précision sonore enveloppante naît de l'alliance harmonieuse de 6 haut-parleurs actifs ultra-précis et de 4 radiateurs passifs sculptés pour sublimer les basses.

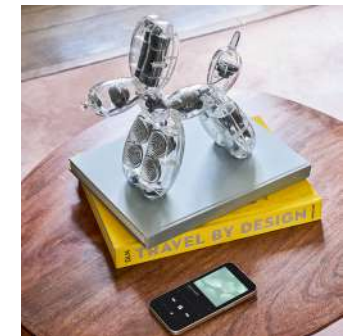

BALLOON DOG SPEAKER

A sculptural 360° speaker built for immersive listening
Une enceinte 360° sculpturale conçue pour une écoute immersive

BALLOON DOG LAMP

A luminous collectible engineered for atmosphere
Un objet de collection lumineux conçu pour créer une atmosphère



They talk about it / Ils en parlent



BALLOON DOG LAMP

BALLOON DOG SPEAKER



- | | | | | | | |
|--|--------------------------------------|------------------------------------|-------------------------------------|-------------------------------|---|-----------------------------------|
| HIGH QUALITY
GLASS-EFFECT ACRYLIC | LED LAMP
WITH 9 COLORS | 9 LIGHTING
ANIMATIONS | 200 LUMENS
BRIGHTNESS | DIMMABLE | INFINITE SYNC VIA
BLUETOOTH® | RECHARGEABLE
VIA USB-C |
| | | | | | | |
| ACRYLIQUE HAUTE
QUALITÉ EFFET VERRE | LAMPE AVEC
9 COULEURS LED | 9 ANIMATIONS
LUMINEUSES | 200 LUMENS
DE LUMINOSITÉ | INTENSITÉ
RÉGLABLE | SYNCHRO INFINIE
VIA BLUETOOTH® | RECHARGEABLE
PAR USB-C |

- | | | | | | | |
|--|-------------------------------------|--------------------------------------|---|-----------------------------|----------------------------|-----------------------------------|
| HIGH QUALITY
GLASS-EFFECT ACRYLIC | 360° BLUETOOTH®
SPEAKER | BUILT-IN
10 SPEAKERS | MIC FOR
HANDS-FREE CALLS | STEREO
PAIRING | 10H
OF PLAYTIME | RECHARGEABLE
VIA USB-C |
| | | | | | | |
| ACRYLIQUE HAUTE
QUALITÉ EFFET VERRE | ENCEINTE
BLUETOOTH® 360° | 10 HAUT-PARLEURS
INTÉGRÉS | MICRO POUR APPELS
MAINS LIBRES | APPARIAGE
STÉRÉO | 10H
D'AUTONOMIE | RECHARGEABLE
PAR USB-C |



Jeff Koons' signature engraved on the front feet
Signature de Jeff Koons gravée sous les pattes avant



Certificate of authenticity with signature and hologram
Certificat d'authenticité avec signature et hologramme



Sync your lamps infinitely, no mobile app required
Synchronisez vos lampes à l'infini sans aucune application mobile nécessaire



Jeff Koons' signature engraved on the front feet
Signature de Jeff Koons gravée sous les pattes avant



Certificate of authenticity with signature and hologram
Certificat d'authenticité avec signature et hologramme



Pair two for an immersive stereo experience, without a mobile app
Connectez-en deux pour une expérience stéréo immersive, sans appli mobile

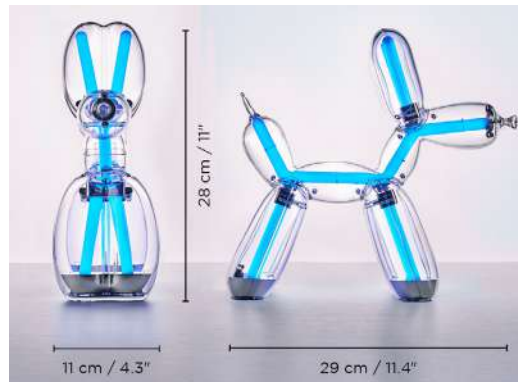

Produit : 29 x 11 x 28 cm
Pack : 34 x 34 x 12,8 cm
Carton : 69 x 37,5 x 37 cm

P. Net : 1 Kg
P. Brut : 2,7 Kg
P. Total : 15 kg

5 pcs



Product: 11.4 x 4.3 x 11.0" N.W: 2.20 lbs
Pack: 13.4 x 13.4 x 5" G.W: 5.95 lbs
Carton: 27.17 x 14.76 x 14.57" T.W: 33 lbs 5 pcs



Produit : 29 x 11 x 28 cm
Pack : 34 x 34 x 12,8 cm
Carton : 69 x 37,5 x 37 cm

P. Net : 1,1 Kg
P. Brut : 2,7 Kg
P. Total : 15 kg

5 pcs



Product: 11.4 x 4.3 x 11.0" N.W: 2.43 lbs
Pack: 13.4 x 13.4 x 5" G.W: 5.95 lbs
Carton: 27.17 x 14.76 x 14.57" T.W: 33 lbs 5 pcs

LEXON® × PANTONE™

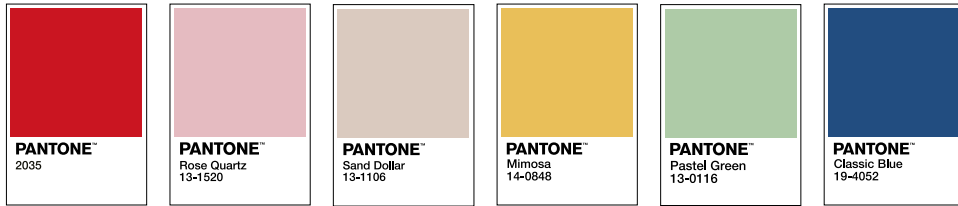

COLLABORATIONS COLLABORATIONS

Color is a vital affirmation of who we are, and living with our favorite colors is the utmost form of self expression. Pantone's universal language of color is the ultimate way to describe and choose your colors. PANTONE transforms insight from the world's color authority into outstanding designs for everyday living.

La couleur est une affirmation vitale de qui nous sommes, et vivre avec nos couleurs préférées est la forme ultime d'expression de soi. Le langage universel des couleurs de Pantone est le moyen ultime de décrire et de choisir vos couleurs. PANTONE transforme les connaissances de l'autorité mondiale des couleurs en des designs exceptionnels pour la vie quotidienne.



AVAILABLE IN INDIVIDUAL GIFT BOX OR LIMITED-RUN GIFT SETS

DISPONIBLE EN PACK INDIVIDUEL OU EN COFFRETS EN SÉRIE LIMITÉE

Limited in production, this exclusive gift set includes all four Lexon products capturing the colors of Pantone's masterpieces.

Produit en série limitée, ce coffret cadeau exclusif comprend les quatre produits Lexon capturant l'essence des couleurs de Pantone.

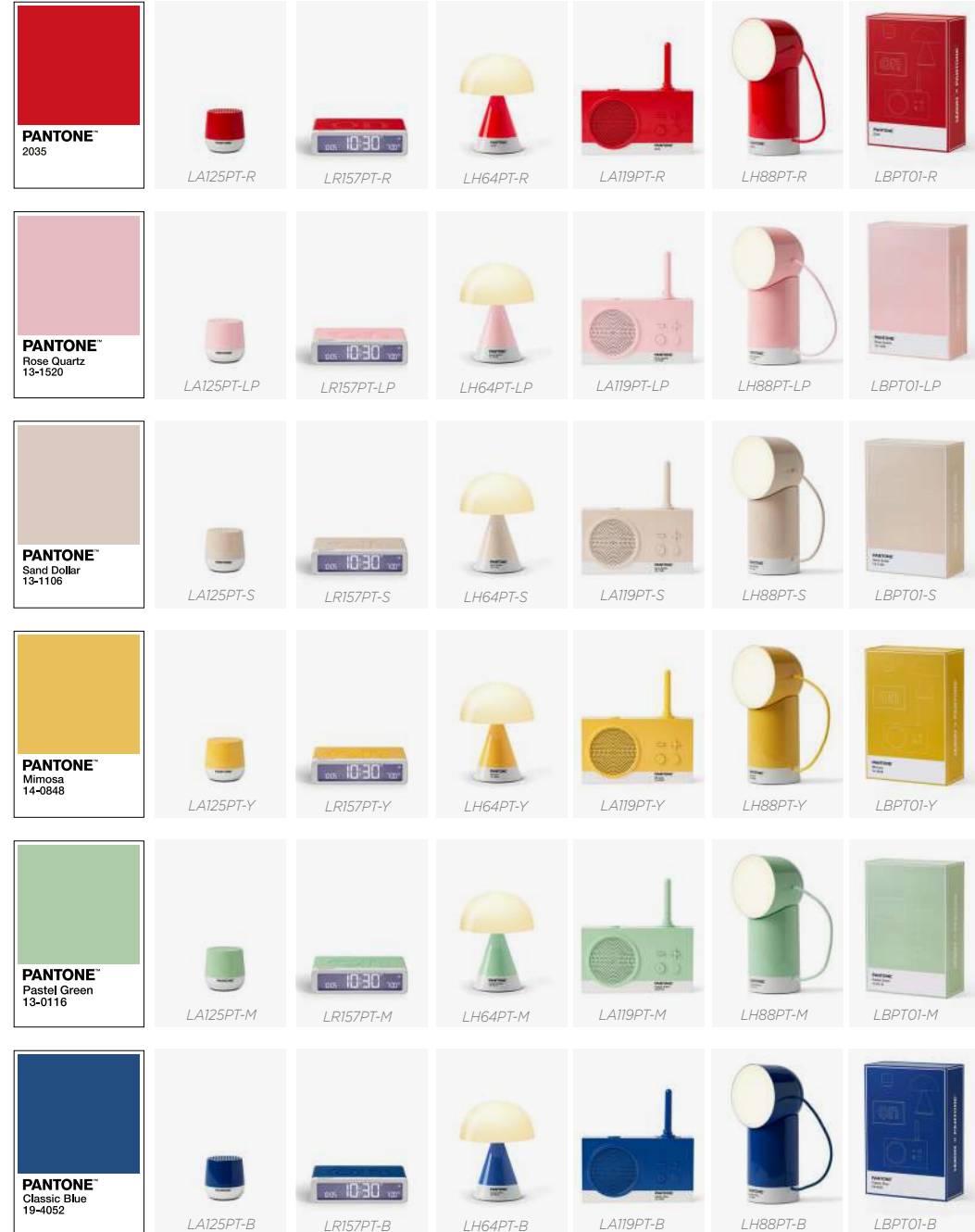

Keith Haring™



COLLABORATIONS COLLABORATIONS

Drawing inspiration from Keith Haring's artistic style, characterized by bold lines, vibrant colors, and symbolic icons, Lexon has skillfully translated Haring's vision into tangible, everyday objects. This collaboration pays homage to Haring's belief that art should be accessible to all, bringing his iconic imagery into the realm of practical, everyday use.

S'inspirant du style artistique de Keith Haring, caractérisé par des lignes audacieuses, des couleurs vibrantes et des icônes symboliques, Lexon a habilement traduit la vision de l'artiste à travers ses objets tangibles du quotidien. Cette collaboration rend hommage à la conviction de Haring selon laquelle l'art doit être accessible à tous, amenant son imagerie emblématique dans le domaine de l'utilisation pratique et quotidienne.



LIMITED-RUN PRODUCTION GIFT SETS COFFRETS EN SÉRIE LIMITÉE

Limited in production, this exclusive gift set includes all four Lexon products capturing the essence of Keith Haring's masterpieces.

Produit en série limitée, ce coffret cadeau exclusif comprend les quatre produits Lexon capturant l'essence des chefs-d'oeuvre de Keith Haring.



 LA125KH-AW	 LR150KH-AW	 LH64KH-AW	 LA119KH-AW
 LA125KH-AB	 LR150KH-AB	 LH64KH-AB	 LA119KH-AB
 LA125KH-AY	 LR150KH-AY	 LH64KH-AY	 LA119KH-AY
 LA125KH-BN	 LR150KH-BN	 LH64KH-BN	 LA119KH-BN
 LA125KH-BR	 LR150KH-BR	 LH64KH-BR	 LA119KH-BR
 LA125KH-BW	 LR150KH-BW	 LH64KH-BW	 LA119KH-BW
 LA125KH-CN	 LR150KH-CN	 LH64KH-CN	 LA119KH-CN
 LA125KH-CB	 LR150KH-CB	 LH64KH-CB	 LA119KH-CB
 LA125KH-CP	 LR150KH-CP	 LH64KH-CP	 LA119KH-CP

JEAN-MICHEL BASQUIAT™



COLLABORATIONS COLLABORATIONS

Pursuing our commitment to blend design and tech, we have reimagined our most popular objects to feature some of Jean-Michel Basquiat's iconic works. This exclusive collaboration embraces Lexon's inherently forward-thinking nature, seamlessly merging it with the artist's bold and exuberant style. The result is an inspiring fusion that celebrates art and creativity in everyday life, forging a harmonious symphony that unites form and function in an extraordinary manner.

Poursuivant notre engagement à allier design et technologie, nous avons réinventé nos objets les plus populaires pour présenter certaines des oeuvres emblématiques de Jean-Michel Basquiat.

Cette collaboration exclusive embrasse la nature intrinsèquement avant-gardiste de Lexon, la fusionnant de manière transparente avec le style audacieux et exubérant de l'artiste. Le résultat est une fusion inspirante qui célèbre l'art et la créativité au quotidien, forgeant une symphonie harmonieuse qui unit forme et fonction d'une manière extraordinaire.



LIMITED-RUN PRODUCTION GIFT SETS COFFRETS EN SÉRIE LIMITÉE

Limited in production, this exclusive gift set includes all four Lexon products capturing the essence of Jean-Michel Basquiat's masterpieces.

Produit en série limitée, ce coffret cadeau exclusif comprend les quatre produits Lexon capturant l'essence des chefs-d'oeuvre de Jean-Michel Basquiat.



LBBSQ01-AN



LBBSQ01-C



LBBSQ01-D



LBBSQ01-B



LA125BSQ-AN

LA125BSQ-AR

LA125BSQ-AP

LA125BSQ-ABG

LA125BSQ-AB

LA125BSQ-AY



LR150BSQ-AN

LR150BSQ-AR

LR150BSQ-AP

LR150BSQ-ABG

LR150BSQ-AB

LR150BSQ-AY

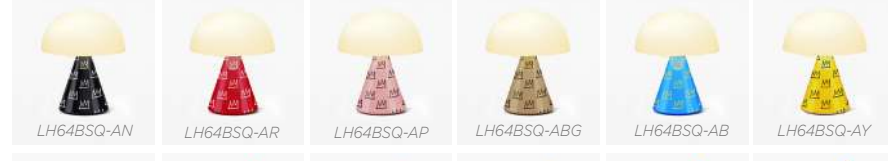

LH64BSQ-AN

LH64BSQ-AR

LH64BSQ-AP

LH64BSQ-ABG

LH64BSQ-AB

LH64BSQ-AY



LA119BSQ-AN

LA119BSQ-AR

LA119BSQ-AP

LA119BSQ-ABG

LA119BSQ-AB

LA119BSQ-AY



LA125BSQ-C

LR150BSQ-C

LH64BSQ-C

LA119BSQ-C



LA125BSQ-D

LR150BSQ-D

LH64BSQ-D

LA119BSQ-D



LA125BSQ-B

LR150BSQ-B

LH64BSQ-B

LA119BSQ-B

Lexon *What's new*

NOVA collection



NOVA S



NOVA M



NOVA L

Nouveautés **Lexon**

CONIC collection



CONIC CLOCK

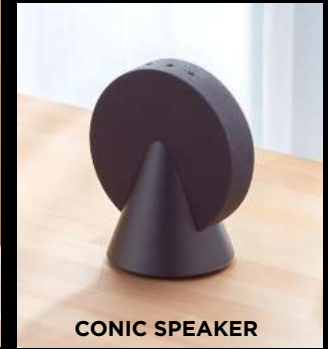

CONIC SPEAKER

STELI collection



STELI CANDLE



STELI S



STELI LOUNGE

ALARM CLOCKS

RÉVEILS



NEW

CONIC
CLOCK



BEST SELLER

FLIP
COLLECTION



MINA
SUNRISE



RAY
CLOCK



MINUT



CONIC CLOCK

Radio alarm clock with FM & built-in Bluetooth® speaker
Radio-réveil avec FM & enceinte Bluetooth® intégrée



- 
RADIO FM
FM RADIO
- 
ENCEINTE BLUETOOTH®
BLUETOOTH® SPEAKER
- 
ÉCRAN VA LCD PURE BLACK
PURE BLACK VA LCD DISPLAY
- 
MÉLODIES ET SONS NATURELS
MELODIES & NATURAL SOUNDS
- 
RÉPÉTITION DE L'ALARME & ÉCLAIRAGE
SNOOZE & LIGHT UP
- 
SUIVI DE LA TEMPÉRATURE INTÉRIEURE ET DE L'HUMIDITÉ
INDOOR TEMPERATURE & HUMIDITY MONITORING
- 
PORT DE CHARGE USB-C
USB-C CHARGING PORT
- 
FINITION ALUMINIUM
ALUMINIUM FINISH



CONIC CLOCK

Design by Lidia Gomez



Radio-réveil avec FM & enceinte Bluetooth® intégrée - Double alarme avec radio FM ou mélodies & sons naturels - Grand écran LCD - Luminosité ajustable - Affichage de la température intérieure et de l'humidité relative - Commandes tactiles pour un accès facile aux modes Bluetooth®/radio FM et aux réglages des paramètres - Rechargeable - Alimenté par USB-C (câble inclus) - Matériaux : Aluminium - ABS.

Radio alarm clock with FM & built-in Bluetooth® speaker - Dual alarm with FM radio or melodies & natural sounds - Large LCD display - Adjustable brightness - Indoor temperature and relative humidity display - Touch controls for easy access to Bluetooth®/FM radio modes and device settings - Rechargeable - Powered by USB-C (cable included) - Material: Aluminum - ABS.

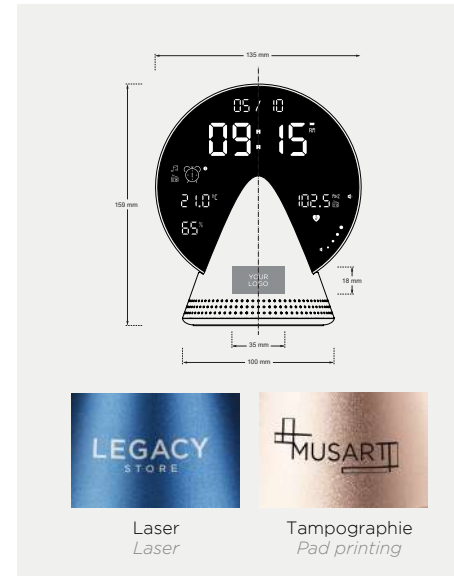

Produit : Ø13,5 x 15,9 cm
 Pack : 17,7 x 11,5 x 23 cm
 Carton : 55 x 48,9 x 26 cm

P. Net : 400 gr
 P. Brut : 690 gr
 P. Total : 9,7 kg

Product: Ø5.31 x 6.26"
 Pack: 6.97 x 4.53 x 9.06"
 Carton: 21.65 x 19.25 x 10.24"

N.W: 0.88 lbs
 G.W: 1.52 lbs
 T.W: 21.38 lbs 12 pcs



FLIP CLASSIC

Reversible alarm clock / Réveil réversible



RÉVEIL RÉVERSIBLE
REVERSIBLE ALARM CLOCK



ÉCRAN LCD ÉLECTROLUMINESCENT
ELECTROLUMINESCENT LCD DISPLAY



LUMINOSITÉ RÉGLABLE
ADJUSTABLE BRIGHTNESS



TOUCHEZ POUR RÉPÉTER L'ALARME & L'ÉCLAIRAGE
TOUCH TO SNOOZE & LIGHT UP



JUSQU'À 6 MOIS D'AUTONOMIE
UP TO 6 MONTHS BATTERY LIFE



RECHARGEABLE PAR USB-C
RECHARGEABLE VIA USB-C



N0 G3 D1 K9 V2
DB9 BF9 R4 O4 J9
P4 LL LB1 M1 W9

FLIP CLASSIC

Design by Adrian & Jeremy Wright



Réveil réversible - Faces ON/OFF - Écran LCD - 3 niveaux de luminosité - Touchez pour répéter l'alarme & l'éclairage - Autonomie : jusqu'à 6 mois - Temps de charge : 4h - Rechargeable par USB-C (cable inclus) - Matériaux : ABS.

Reversible alarm clock - ON/OFF faces - LCD display - 3 Brightness levels - Touch sensor snooze/light - Battery life: up to 6 months - Charging time: 4h - Rechargeable via USB-C (cable included) - Material: ABS.

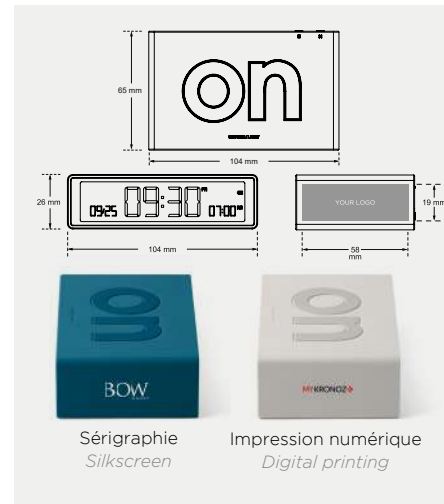

Produit : 10.4 x 6.5 x 2.6 cm P. Net : 125 gr
Pack : 10.7 x 3.5 x 8.8 cm P. Brut : 156 gr
Carton : 37.6 x 23 x 21 cm P. Total : 81 kg 40 pcs



Product: 4.09 x 2.55 x 1.02" N.W: 0.28 lbs
Pack: 4.21 x 1.38 x 3.46" G.W: 0.34 lbs
Carton: 14.80 x 9.05 x 8.27" T.W: 17.85 lbs 40 pcs

FLIP MINI

Mini reversible alarm clock / Mini réveil réversible

AWARDS



RÉVEIL RÉVERSIBLE



REVERSIBLE ALARM CLOCK

ÉCRAN LCD ÉLECTROLUMINESCENT



ELECTROLUMINESCENT LCD DISPLAY

LUMINOSITÉ RÉGLABLE



ADJUSTABLE BRIGHTNES

TOUCHEZ POUR RÉPÉTER L'ALARME & L'ÉCLAIRAGE



TOUCH TO SNOOZE & LIGHT UP

JUSQU'À 6 MOIS D'AUTONOMIE



UP TO 6 MONTHS BATTERY LIFE

RECHARGEABLE PAR USB-C



RECHARGEABLE VIA USB-C



FLIP MINI

Design by Adrian & Jeremy Wright



Mini réveil réversible de voyage - Faces ON/OFF - Écran LCD - 3 niveaux de luminosité - Touchez pour répéter l'alarme & l'éclairage - Autonomie : jusqu'à 6 mois - Temps de charge : 2h - Rechargeable par USB-C (cable inclus - Matériaux : ABS

Mini reversible alarm clock - ON/OFF faces - LCD display - 3 Brightness levels - Touch sensor snooze/light - Battery life: up to 6 months - Charging time: 2h - Rechargeable via USB-C (cable included) - Material: ABS.

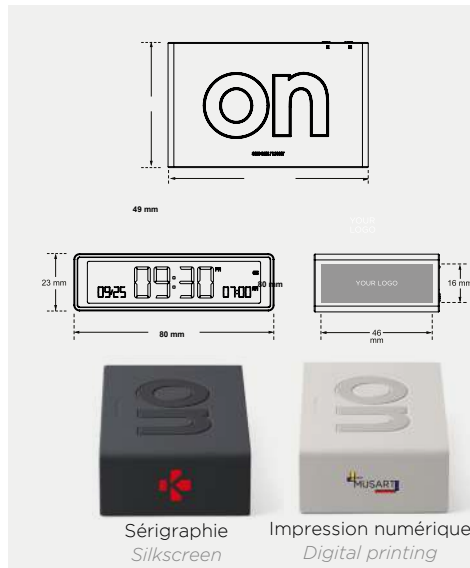

Produit :	8.0 x 4.9 x 2.3 cm	P. Net :	68 gr	Product :	3.14 x 1.92 x 0.9"	N.W. :	0.15 lbs	
Pack :	8.4 x 3.2 x 7.6 cm	P. Brut :	120 gr	Pack :	3.31 x 1.26 x 2.99"	G.W. :	0.26 lbs	
Carton :	18.5 x 34.5 x 18 cm	P. Total :	6.2 kg	40 pcs	Carton :	7.28 x 13.58 x 7.09"	T.W. :	13.67 lbs

FLIP PREMIUM

Reversible LCD alarm clock in aluminum
Réveil LCD réversible en aluminium

FLIP PREMIUM

Design by Adrian & Jeremy Wright



AWARDS

reddot winner 2022

GOOD DESIGN



- RÉVEIL RÉVERSIBLE**
REVERSIBLE ALARM CLOCK
- ÉCRAN VA LCD PURE BLACK**
PURE BLACK VA LCD DISPLAY
- CAPTEUR SONORE POUR ACTIVATION DE L'ÉCRAN**
SOUND SENSOR TO ACTIVATE SCREEN
- RÉPÉTITION DE L'ALARME & ÉCLAIRAGE**
SNOOZE & LIGHT UP
- VOLUME D'ALARME RÉGLABLE**
ADJUSTABLE ALARM VOLUME
- JUSQU'À 6 MOIS D'AUTONOMIE**
UP TO 6 MONTHS BATTERY LIFE
- RECHARGEABLE PAR USB-C**
RECHARGEABLE VIA USB-C
- FINITION ALUMINIUM**
ALUMINIUM FINISH



Réveil LCD réversible - Faces ON/OFF - Écran VA LCD pure black - Capteur sonore pour activation de l'écran - Commandes tactiles pour répéter l'alarme et ajuster la luminosité - Sonneries d'alarme avec volume ajustable - Mode nuit - Autonomie : jusqu'à 6 mois - Rechargeable par USB-C (câble inclus) - Matériaux : Aluminium - PC.

Reversible LCD alarm clock - ON/OFF faces - Pure VA LCD display - Sound sensor to wake-up screen - Touch control for snooze and dimmer - 3 alarm tones with volume adjustment - Night mode - Battery life: up to 6 months - Rechargeable via USB-C (cable included) - Material: Aluminum - PC.

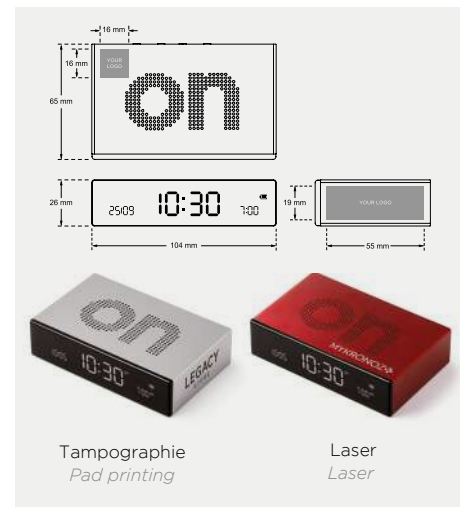

Produit :	10.4 x 6.5 x 2.6 cm	P. Net :	165 gr	Product:	4.09 x 2.55 x 1.02"	N.W.:	0.4 lbs
Pack :	10.7 x 3.5 x 8.8 cm	P. Brut :	228 gr	Pack:	4.21 x 1.38 x 3.46"	G.W.:	0.5 lbs
Carton :	37.6 x 23 x 21 cm	P. Total :	9.7 kg	Carton:	14.80 x 9.05 x 8.2"	T.W.:	21.38 lbs

40 pcs

MINA SUNRISE

Sunrise alarm clock / Lampe réveil simulateur d'aube



SIMULATION DE L'AUBE ET DU CRÉPUSCULE



SUNRISE & SUNSET SIMULATION

MÉLODIES ET SONS NATURELS



MELODIES & NATURAL SOUNDS

RÉPÉTITION DE L'ALARME



SNOOZE & DIMMER

LAMPE LED AVEC 9 COULEURS D'ÉCLAIRAGE



LED LAMP WITH 9 COLORS

PORT DE CHARGE USB-C



USB-C CHARGING PORT

FINITION ALUMINIUM



ALUMINIUM FINISH



MINA SUNRISE

Design by Manuela Simonelli & Andrea Quaglio



Lampe réveil simulateur d'aube - Écran LCD VA pur - Simulation du lever et du coucher du soleil - Mélodies & sons naturels - Lampe avec 9 couleurs de LED - Puissance lumineuse maximale : 70 lm - Variateur d'intensité - Commandes tactiles - Rechargeable - Jusqu'à 4 mois d'autonomie - Temps de charge : 5h - Rechargeable par USB-C (câble inclus) - Matériaux : Aluminium - ABS.

Sunrise alarm clock - Pure VA LCD display - Sunrise & Sunset simulation - Melodies & natural sounds - Lamp with 9 LED colors - Maximum light output: 70 lm - Dimmer - Touch controls - Rechargeable - Up to 4 months of battery life - Charging time: 5h - Rechargeable via USB-C (cable included) - Material: Aluminum - ABS.

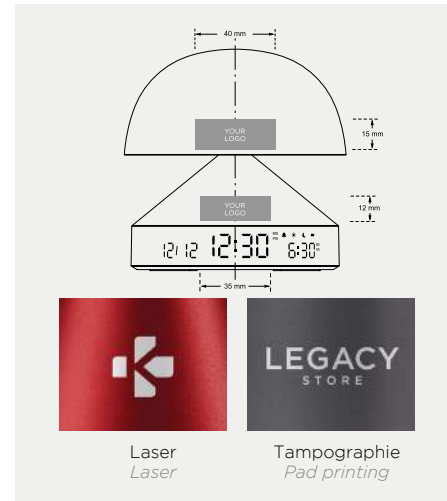

Produit : Ø11 x 11 cm
 Pack : 15.2 x 15.2 x 12 cm
 Carton : 61.9 x 31.5 x 33.3 cm
 P. Net : 235 gr
 P. Brut : 430 gr
 P. Total : 9.6 kg 20 pcs

Product: Ø 4.33" x 4.33"
 Pack: 5.98 x 5.98 x 4.72"
 Carton: 24.37 x 12.40 x 13.11"
 N.W.: 0.52 lbs
 G.W.: 0.95 lbs
 T.W.: 21.17 lbs 20 pcs

RAY CLOCK

Alarm clock with thermometer and hygrometer
Réveil avec thermomètre et hygromètre

RAY CLOCK

Design by neil poulton



ÉCRAN VA LCD
PURE BLACK



PURE BLACK
VA LCD DISPLAY

MÉLODIES ET SONS
NATURELS



MELODIES &
NATURAL SOUNDS

RÉPÉTITION DE
L'ALARME
& ÉCLAIRAGE



SNOOZE
& LIGHT UP

SUIVI DE LA TEMPÉRATURE
INTÉRIEURE ET DE
L'HUMIDITÉ



INDOOR TEMPERATURE &
HUMIDITY MONITORING

RECHARGEABLE
PAR USB-C



RECHARGEABLE
VIA USB-C

FINITION
ALUMINIUM



ALUMINIUM
FINISH



VG3



OB3



SR3



MN3



RA3

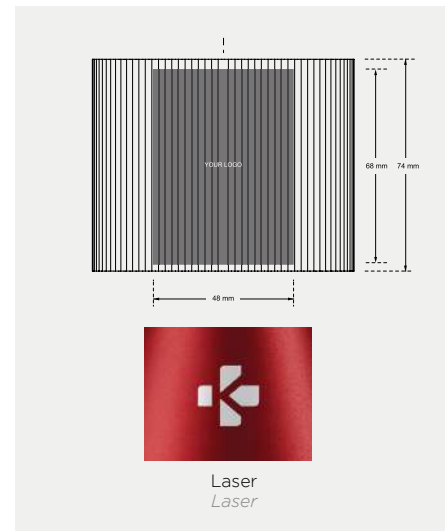

Produit : 9 x 4,4 x 7,4 cm
Pack : 12,7 x 5,2 x 11 cm
Carton : 53 x 27,8 x 25,2 cm

P. Net : 230 gr
P. Brut : 309 gr
P. Total : 13,6 kg

40 pcs



Product: 3.54 x 1.73 x 2.91"
Pack: 5 x 2.05 x 4.33"
Carton: 20.87 x 10.94 x 9.92"

N.W: 0.51 lbs
G.W: 0.68 lbs
T.W: 29.98 lbs

40 pcs

Réveil LCD avec affichage température/humidité - Fonction snooze - Inclinaison pour activer/désactiver l'alarme - Mélodies & sons naturels - Affichage de la température intérieure et de l'humidité relative - Autonomie : Jusqu'à 6 mois - Rechargeable par USB-C (câble inclus) - Temps de charge : 4h - Matériaux : Aluminium - ABS.

LCD alarm clock with temperature/humidity display - Snooze function - Tilt to activate/deactivate alarm - Melodies & natural sounds - Indoor temperature and relative humidity display - Battery life: Up to 6 months - Rechargeable via USB-C (cable included) - Charging time: 4h - Material: Aluminum - ABS.

MINUT

Mini alarm clock / Mini réveil

MINUT

Design by Manuela Simonelli & Andrea Quaglio



AWARD



reddot winner 2023



- FORMAT DE POCHÉ**

POCKET-SIZED
- ÉCRAN VA LCD PURE BLACK**

PURE BLACK VA LCD DISPLAY
- RÉPÉTITION DE L'ALARME & ÉCLAIRAGE**

SNOOZE & LIGHT UP
- JUSQU'À 6 MOIS D'AUTONOMIE**

UP TO 6 MONTHS BATTERY LIFE
- RECHARGEABLE PAR USB-C**

RECHARGEABLE VIA USB-C
- FINITION ALUMINIUM**

ALUMINIUM FINISH



Réveil compact avec écran LCD noir et batterie rechargeable intégrée - Commandes tactiles - Fonction snooze - Autonomie : Jusqu'à 6 mois - Temps de charge : 3h - Rechargeable par USB-C - Matériaux : Aluminium - ABS.

Compact size alarm clock with full black LCD display - Rechargeable built-in battery - Touch controls - Snooze function - Battery life: Up to 6 months - Charging time: 3h - Rechargeable via USB-C - Material: Aluminum - ABS.



AP



BF



N



D



LB1



LP



DR



DG1



X

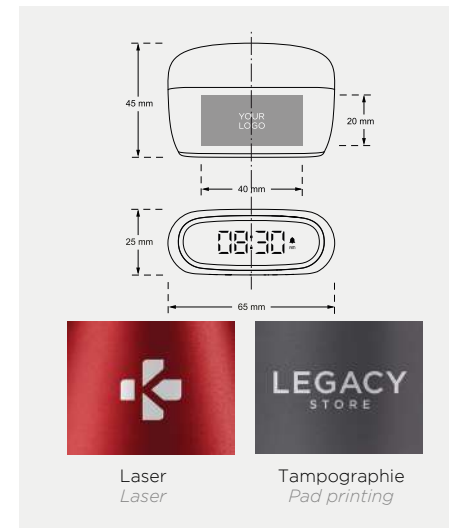

Produit :	6.5 x 4.5 x 2.5 cm	P. Net :	50 gr
Pack :	8.4 x 3.2 x 7.6 cm	P. Brut :	95 gr
Carton :	18.5 x 34.5 x 18 cm	P. Total :	4.1 kg 40 pcs

Product:	2.56 x 1.77 x 0.98"	N.W.:	0.11 lbs
Pack:	3.31 x 1.26 x 2.99"	G.W.:	0.21 lbs
Carton:	7.28 x 13.58 x 7.09"	T.W.:	9.04 lbs 40 pcs

AUDIO
AUDIO



NEW

**CONIC
SPEAKER**



**OSLO NEWS
PREMIUM**



BEST SELLER



TYKHO 3

**MINO
COLLECTION**



**RAY
SPEAKER**



TAMO



**SPEAKER-
BUDS**



CONIC SPEAKER

360° Bluetooth® speaker / Enceinte Bluetooth® 360°

CONIC SPEAKER

Design by Lidia Gomez



AWARDS

reddot winner 2024

- ENCEINTE BLUETOOTH®**

BLUETOOTH® SPEAKER
- SON 360°**

360° SOUND
- APPAIRABLE PAR TWS**

PAIRABLE VIA TWS
- BOUTONS POUR LES COMMANDES AUDIO**

BUTTONS FOR AUDIO CONTROLS
- RECHARGEABLE PAR USB-C**

RECHARGEABLE VIA USB-C
- BASE EN ALUMINIUM**

ALUMINIUM BASE

Enceinte Bluetooth® 360° - Configuration audio composée de 2 haut-parleurs actifs et 1 haut-parleur de basse - Boutons pour les commandes audio et ajustement du volume - Compatible TWS pour une expérience stéréo - Autonomie : Jusqu'à 12h - Rechargeable par USB-C (câble inclus) - Temps de charge : 4h - Matériaux : Aluminium - Tissu - ABS.

360° Bluetooth® speaker - Audio configuration featuring 2 active drivers and 1 passive driver - Buttons for audio controls and volume adjustment - TWS compatible for a stereo experience - Battery life: Up to 12h - Rechargeable via USB-C (cable included) - Charging time: 4h - Material: Aluminum - Fabric - ABS.

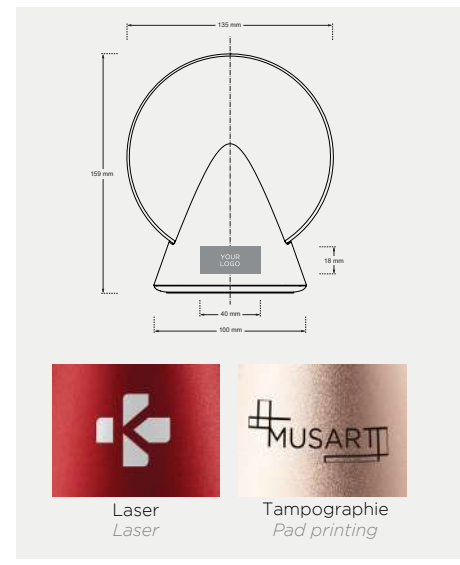

Produit : Ø13.5 x 15.9 cm
 Pack : 17.7 x 11.5 x 23 cm
 Carton : 55 x 48.9 x 26 cm

P. Net : 508 gr
 P. Brut : 750 gr
 P. Total : 10.9 kg

12 pcs

Product: Ø5.31 x 6.26"
 Pack: 6.97 x 4.53 x 9.06"
 Carton: 21.65 x 19.25 x 10.2"

N.W: 1.12 lbs
 G.W: 1.65 lbs
 T.W: 24.03 lbs

TYKHO 3

FM radio & Bluetooth® speaker / Radio FM & enceinte Bluetooth®

AWARD



RADIO FM



FM RADIO

ENCEINTE BLUETOOTH



BLUETOOTH SPEAKER

20H D'AUTONOMIE



20H PLAYTIME

RECHARGEABLE PAR USB-C



RECHARGEABLE VIA USB-C

RÉSISTE AUX ÉCLABOUSSURES



RÉSISTE AUX ÉCLABOUSSURES

RESIN



D1 W9 R4 P4 O4

SILICONE



V2 LB1 LL K9 M1



DB9 B9 G3 N1 J8

TYKHO 3

Design by Marc Berthier



Radio FM - Enceinte Bluetooth® - Résiste aux projections d'eau - Plage de fréquence : FM 88-108 MHz - Portée Bluetooth® : 10m - Autonomie : 20h - Temps de charge : 4h - Rechargeable par USB-C (câble inclus) - Matériaux : Gomme siliconée ou résine.

FM radio - Bluetooth® speaker - Splash-proof - Frequency range: FM 88-108MHz - Bluetooth® range: 10m - Battery life: 20h - Charging time: 4h - Rechargeable via USB-C port (cable included) - Material: Silicone rubber case or Resin.

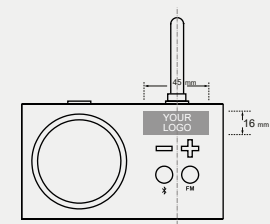

Laser (uniquement sur silicone)
Laser (silicone finish only)

Sérigraphie (uniquement sur résine)
Silkscreen (resin finish only)



Produit : 14 x 4,5 x 8,1 cm
Pack : 17,6 x 5 x 17 cm
Carton : 38,9 x 29,8 x 42,8 cm

P. Net : 307 gr
P. Brut : 388 gr
P. Total : 10,95 kg

Product: 5.51 x 1.77 x 3.19"
Pack: 6.93 x 1.97 x 6.69"
Carton: 15.31 x 11.73 x 16.85"

N.W: 0.68 lbs
G.W: 0.85 lbs
T.W: 24.14 lbs

20 pcs



MINO+

Mini Bluetooth® speaker / Mini enceinte Bluetooth®

MINO+

Design by Manuela Simonelli & Andrea Quaglio



AWARD
reddot winner 2021



- ENCEINTE BLUETOOTH**



BLUETOOTH SPEAKER
- APPARABLE PAR TWS**



PAIRABLE VIA TWS
- MICRO MAINS-LIBRES**



HANDS-FREE MIC
- DÉCLENCHEUR SELFIE**



SELFIE REMOTE
- PORT USB-C**



USB-C PORT
- RECHARGEABLE PAR INDUCTION**



WIRELESSLY RECHARGEABLE
- FINITION EN ALUMINIUM**



ALUMINUM FINISH

Enceinte Bluetooth® rechargeable par induction - Appairable - Micro mains-libres - Déclencheur selfie - Autonomie : 3h - Temps de charge : 1h - Rechargeable par USB-C (câble inclus) ou par induction - Matériaux : Aluminium - ABS.

Wirelessly rechargeable Bluetooth® speaker - Pairable - Hands-free mic - Selfie control - Battery life: 3h - Charging time: 1h - Rechargeable via USB-C (cable included) or wirelessly - Material: Aluminum - ABS.



Colors on request / Couleurs sur demande

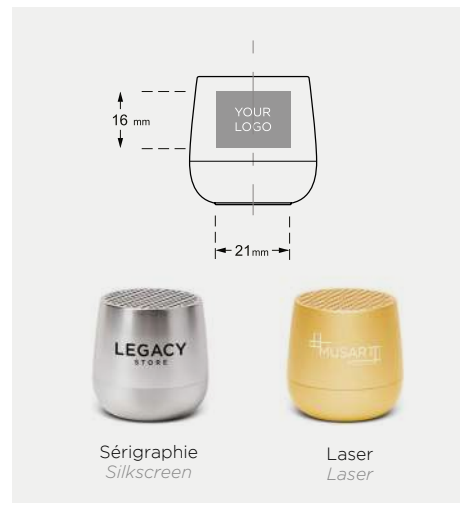

Produit : Ø3.7 x 3.7 cm
 Pack : 7.5 x 4 x 8.5 cm
 Carton : 43 x 16.5 x 20 cm

P. Net : 33 gr
 P. Brut : 73 gr
 P. Total : 3.5 kg

Product: Ø1.46 x 1.46" N.W: 0.07 lbs
 Pack: 2.95 x 1.57 x 3.34" G.W: 0.16 lbs
 Carton: 16.93 x 6.49 x 7.87" T.W: 7.71 lbs 40 pcs

MINO X

Floating Bluetooth® speaker / Enceinte Bluetooth® flottante

MINO X

Design by Manuela Simonelli & Andrea Quaglio



AWARD



reddot winner 2020

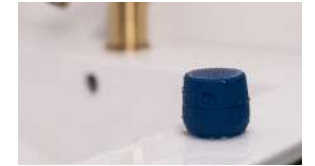

Enceinte Bluetooth® flottante - Résistance à l'eau IPX7 - Appairable - Rechargeable - Micro mains-libres - Déclencheur selfie - Autonomie : 3h - Temps de charge : 1h - Rechargeable par USB-C (câble inclus) - Matériaux : ABS - gomme rebondissante - finition silicone.

Floating Bluetooth® speaker - Water resistance IPX7 - Pairable - Rechargeable - Hands-free mic - Selfie control - Battery life: 3h - Charging time: 1h - Rechargeable via USB-C (cable included) - Material: ABS - bouncy rubber - silicone finish.

ENCEINTE
BLUETOOTHBLUETOOTH
SPEAKERAPPAIRABLE
PAR TWSPAIRABLE
VIA TWSMICRO
MAINS-LIBRESHANDS-FREE
MICDÉCLENCHEUR
SELFIESELFIE
REMOTERECHARGEABLE
PAR USB-CRECHARGEABLE
VIA USB-CRÉSISTANCE
À L'EAU IPX7IPX7 WATER
RESISTANT

MW



Y9



P9



B9



DB9



O9



R9



K9

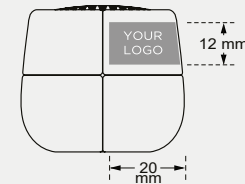

N9

Sérigraphie encre
siliconée
Silicone ink silkscreenLaser
Laser

Produit : Ø4.3 x 4 cm
Pack : 9 x 4.9 x 10.5 cm
Carton : 41.3 x 28 x 26.1 cm

P. Net : 44 gr
P. Brut : 135 gr
P. Total : 619 gr 40 pcs

Product: Ø1.69 x 1.57" N.W: 0.1 lbs
Pack: 3.54 x 1.92 x 4.13" G.W: 0.29 lbs
Carton: 16.25 x 11.02 x 10.27" T.W: 13.65 lbs 40 pcs

MINO T

Bluetooth® speaker with built-in carabiner
 Enceinte Bluetooth® avec mousqueton intégré



AWARD
 reddy winner 2021

- ENCEINTE BLUETOOTH**



BLUETOOTH SPEAKER
- APPARABLE PAR TWS**



PAIRABLE VIA TWS
- MOUSQUETON EN ACIER INOXYDABLE**



STAINLESS STEEL CARABINER
- MICRO MAINS-LIBRES**



HANDS-FREE MIC
- DÉCLENCHEUR SELFIE**



SELFIE REMOTE
- RECHARGEABLE PAR USB-C**



RECHARGEABLE VIA USB-C
- ADAPTÉE À UN USAGE EXTÉRIEUR (IPX4)**



SUITABLE FOR OUTDOOR USE (IPX4)

MINO T

Design by Manuela Simonelli & Andrea Quaglio



Enceinte Bluetooth® avec mousqueton intégré - Appairable par TWS - Micro mains-libres - Déclencheur selfie - Résistance à l'eau IPX4 - Autonomie : 5h - Temps de charge : 2h - Rechargeable par USB-C (câble inclus) - Matériaux : Socle en ABS - Mousqueton en ABS - Alliage de zinc.

Bluetooth® speaker with integrated carabiner - Pairable via TWS - Hands-free mic - Selfie control - Water resistance IPX4 - Playtime: 5h - Charging time: 2h - Rechargeable via USB-C (cable included) - Material: ABS stand - ABS - Zinc alloy hook.

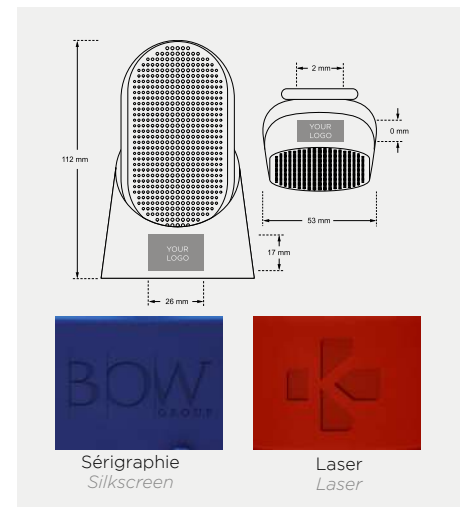

Produit :	5.3 x 2.9 x 9.7 cm	P. Net :	121 gr	Product:	2.08 x 1.14 x 3.81"	N.W:	0.27 lbs
Pack :	9 x 10.3 x 17.7 cm	P. Brut :	310 gr	Pack:	3.54 x 4.05 x 6.97"	G.W:	0.7 lbs
Carton :	48 x 22.5 x 38.6 cm	P. Total :	6.6 kg	Carton:	18.9 x 8.86 x 15.2"	T.W:	14.55 lbs
			20 pcs				20 pcs

MINO+ L

Portable Bluetooth® speaker / Enceinte Bluetooth® nomade

MINO+ L

Design by Manuela Simonelli & Andrea Quaglio



- ENCEINTE BLUETOOTH**



BLUETOOTH SPEAKER
- APPAIRABLE PAR TWS**



PAIRABLE VIA TWS
- MICRO MAINS-LIBRES**



HANDS-FREE MIC
- DÉCLENCHEUR SELFIE**



SELFIE REMOTE
- PORT DE CHARGE USB-C**



USB-C CHARGING PORT
- RECHARGEABLE PAR INDUCTION**



WIRELESSLY RECHARGEABLE
- ADAPTÉE À UN USAGE EXTÉRIEUR (IPX4)**



SUITABLE FOR OUTDOOR USE (IPX4)
- FINITION EN ALUMINIUM**



ALUMINUM FINISH

Enceinte Bluetooth® adaptée pour l'extérieur - Fonction TWS pour une expérience stéréo - Batterie rechargeable - Résistance à l'eau classée IPX4 pour un usage en extérieur (conception étanche aux éclaboussures et au sable) - Micro mains-libres intégré pour les conférences téléphoniques - Autonomie: 5h - Temps de charge: 2h - Rechargeable sur port USB-C (câble inclus) ou par induction - Matériaux : Aluminium - ABS.

Outdoor friendly Bluetooth® speaker - TWS compatible for stereo effect - Rechargeable battery and IPX4 rating for outdoor usage (spillproof and sand proof design) - Hands-free and built-in microphone for conference calls - Battery life: 5h - Charging time: 2h - Rechargeable on USB-C port (cable included) or wirelessly - Material: Aluminum - ABS.

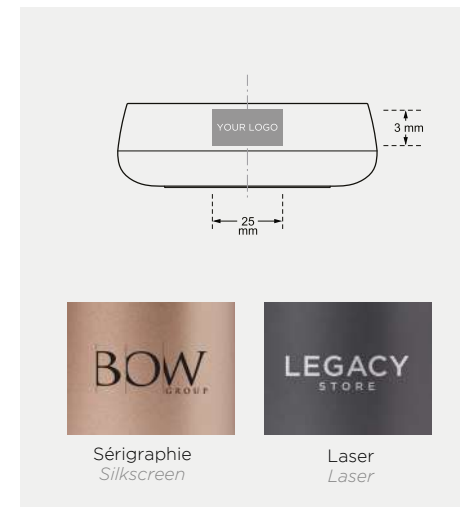

Produit :	Ø9.3 x 3 cm	P. Net :	231 gr
Pack :	12.8 x 4.2 x 12.7 cm	P. Brut :	358 gr
Carton :	27.2 x 23.4 x 28.2 cm	P. Total :	7 kg 20 pcs

Product:	Ø3.66 x 1.18"	N.W.:	0.51 lbs
Pack:	5.04 x 1.65 x 5.0"	G.W.:	0.8 lbs
Carton:	10.71 x 9.21 x 11.1"	T.W.:	15.43 lbs 20 pcs

MINO S

Pocket-sized Bluetooth® speaker / Enceinte Bluetooth® de poche

MINO S

Design by Manuela Simonelli & Andrea Quaglio



**ENCEINTE
BLUETOOTH**

BLUETOOTH
SPEAKER

**APPARABLE
PAR TWS**

PAIRABLE
VIA TWS

**MICRO
MAINS-LIBRES**

HANDS-FREE
MIC

**DÉCLENCHEUR
SELFIE**

SELFIE
REMOTE

**RECHARGEABLE
PAR USB-C**

RECHARGEABLE
VIA USB-C

Enceinte Bluetooth® de poche - Appairable par TWS - Rechargeable - Micro mains-libres - Déclencheur selfie - Autonomie : 3h - Temps de charge : 1h - Rechargeable par USB-C (câble inclus) - Matériaux : ABS.

Pocket-sized Bluetooth® speaker - Pairable via TWS - Rechargeable - Hands-free mic - Selfie control - Playtime: 3h - Charging time: 1h - Rechargeable via USB-C (cable included) - Material: ABS.



N9



DB9



K9



PO



R9



MW

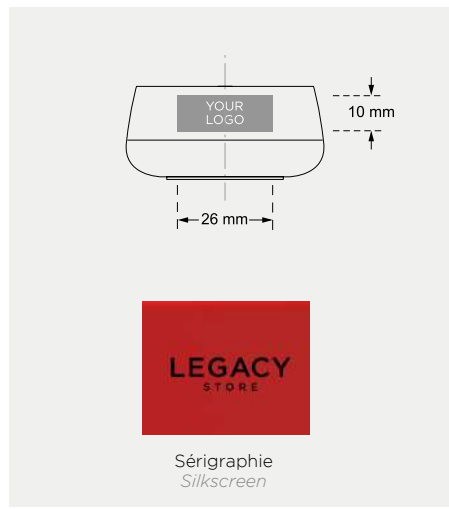

Produit : Ø5.4 x 2.5 cm
Pack : 9 x 4 x 9 cm
Carton : 41.4 x 23.5 x 23.2 cm

P. Net : 43 gr
P. Brut : 85 gr
P. Total : 3.95 kg 40 pcs

Product: Ø2.12 x 0.98" N.W: 0.09 lbs
Pack: 3.54 x 1.57 x 3.54" G.W: 0.19 lbs
Carton: 16.3 x 9.25 x 9.13" T.W: 8.75 lbs 40 pcs

RAY SPEAKER

Set of magnetic Bluetooth® speakers / Duo d'enceintes Bluetooth® magnétiques

RAY SPEAKER

Design by neil poulton



AWARDS

- reddot winner 2024
- DESIGN AWARD 2024
- GOOD DESIGN
- EUROPEAN PRODUCT DESIGN AWARD

- SET D'ENCEINTES BLUETOOTH®**
BLUETOOTH SPEAKER SET
- APPARABLE PAR TWS**
PAIRABLE VIA TWS
- FIXATION MAGNÉTIQUE**
MAGNETIC ATTACHMENT
- RECHARGEABLE PAR USB-C**
RECHARGEABLE VIA USB-C
- ADAPTÉE À UN USAGE EXTÉRIEUR (IPX4)**
SUITABLE FOR OUTDOOR USE (IPX4)
- FINITION ALUMINIUM**
ALUMINIUM FINISH



Duo d'enceintes Bluetooth® magnétiques - Compatible TWS pour une expérience stéréo - Résistante à l'eau (IPX4) - Autonomie : Jusqu'à 6h - Rechargeable par USB-C (câble inclus) - Temps de charge : 2h - Matériaux : Aluminium - Métal magnétique - ABS - Silicone.

Set of magnetic Bluetooth® speakers - TWS compatible for a stereo experience - Water resistant (IPX4) - Battery life: up to 6h - Rechargeable via USB-C (cable included) - Charge time: 2h - Material: Aluminum - Magnetic metal - ABS - Silicon.

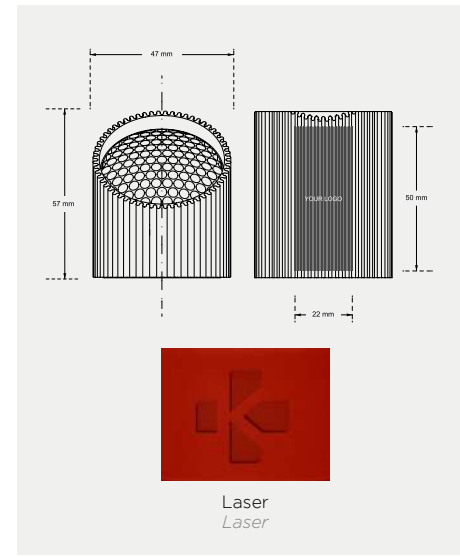

Produit : Ø4.8 x 5.7 cm
 Pack : 15.1 x 5.4 x 10.1 cm
 Carton : 56.7 x 31.8 x 23.4 cm

P. Net : 2x 105 g
 P. Brut : 277 gr
 P. Total : 12 kg 40 pcs

Product: Ø1.89 x 2.24"
 Pack: 5.95 x 2.12 x 3.97"
 Carton: 22.32 x 12.52 x 9.21"

N.W: 2 x 0.23 lbs
 G.W: 0.61 lbs
 T.W: 26.45 lbs 40 pcs

TAMO

Infinitely pairable mini Bluetooth® speaker
Mini enceinte Bluetooth® connectable à l'infini

TAMO

Design by Manuela Simonelli & Andrea Quaglio



AWARDS



reddot winner 2025



Connect multiple Tamo together easily!
Connectez facilement plusieurs Tamo ensemble !

- ENCEINTE BLUETOOTH**



BLUETOOTH SPEAKER
- CONNECTABLE À L'INFINI**



INFINITELY PAIRABLE
- CONTRÔLE TACTILE POUR LES COMMANDES AUDIO**



TOUCH CONTROL FOR AUDIO CONTROLS
- MICRO MAINS-LIBRES**



HANDS-FREE MIC
- DÉCLENCHEUR SELFIE**



SELFIE REMOTE
- RECHARGEABLE PAR USB-C**



RECHARGEABLE VIA USB-C
- RECHARGEABLE PAR INDUCTION**



WIRELESSLY RECHARGEABLE
- FINITION EN ALUMINIUM**



ALUMINIUM FINISH

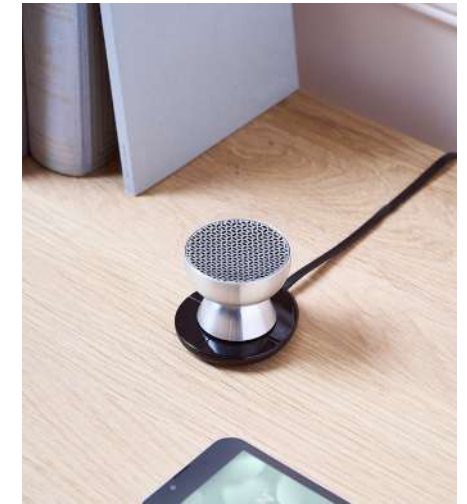

Mini enceinte Bluetooth® connectable à l'infini - Commande tactile sur la base pour les commandes audio et ajustement du volume - Micro mains libres - Déclencheur selfie - Autonomie : Jusqu'à 3h - Rechargeable par USB-C (câble inclus) ou par induction - Temps de charge : 1h - Matériaux : Aluminium - ABS.

Infinitely pairable mini Bluetooth® speaker - Touch control on base for audio controls and volume adjustment - Hands-free microphone - Selfie control - Battery life: Up to 3h - Rechargeable via USB-C (cable included) or wirelessly - Charging time: 1h - Material: Aluminum - ABS.

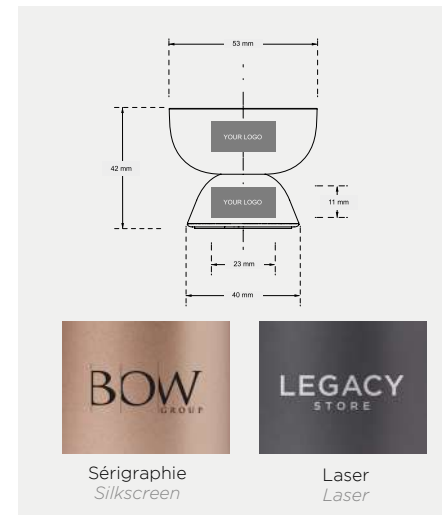

Produit : Ø5.3x 4.2 cm P. Net : 55 gr
 Pack : 9.2 x 5.9 x 8.4 cm P. Brut : 109 gr
 Carton : 38.8 x 31.3 x 19.8 cm P. Total : 5 kg 40 pcs

Product: Ø2.09 x 1.65" N.W: 0.12 lbs
 Pack: 3.62 x 2.32 x 8.4" G.W: 0.24 lbs
 Carton: 15.17 x 12.32 x 7.7" T.W: 11.02 lbs 40 pcs

OSLO NEWS PREMIUM

DAB & FM alarm clock radio / Bluetooth® speaker / Wireless charger
 Radio-réveil DAB & FM / Enceinte Bluetooth® / Chargeur à induction

OSLO NEWS PREMIUM

Design by Manuela Simonelli & Andrea Quaglio



<p>RADIO RÉVEIL DAB + FM</p> <p>DAB + FM ALARM CLOCK RADIO</p>	<p>ENCEINTE BLUETOOTH®</p> <p>BLUETOOTH® SPEAKER</p>	<p>ÉCRAN COULEUR</p> <p>COLOR SCREEN</p>	<p>STATION DE CHARGE SANS FIL 10W</p> <p>WIRELESS CHARGING STATION 10W</p>	<p>CERTIFIÉ Qi</p> <p>Qi CERTIFIED</p>	<p>RECHARGEABLE PAR USB-C</p> <p>RECHARGEABLE VIA USB-C</p>
---	---	---	---	---	--

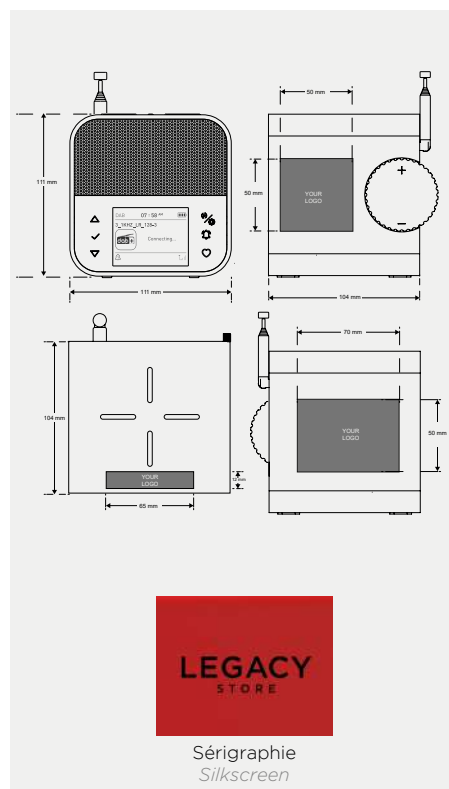

Radio-réveil DAB/FM avec solution de charge par induction - Enceinte Bluetooth® - Écran couleur - fonctionne avec tous les appareils compatibles Qi - Alimenté par un connecteur USB-C (non inclus) - par USB-C (câble inclus) - Matériaux : Cuir synthétique - ABS.

DAB & FM Alarm clock radio with Qi wireless charging - Bluetooth® speaker and FM Radio compatible - Operated with front color screen - Compatible with any Qi devices - Powered with USB-C connector (not included) - via USB-C (cable included) - Material: Synthetic leather - ABS.



N



W



Colors on request / Couleurs sur demande

LEGACY STORE

Sérigraphie
Silkscreen



Produit : 11.1 x 10.44 x 11.1 cm P. Net : 510 gr
 Pack : 16.5 x 16.2 x 12.8 cm P. Brut : 800 gr
 Carton : 50.8 x 34.5 x 28 cm P. Total : 9.9 kg 12 pcs

Product: 4.37 x 4.11 x 4.37" N.W: 1.12 lbs
 Pack: 6.5 x 6.38 x 5.04" G.W: 1.76 lbs
 Carton: 20.00 x 13.58 x 11.02" T.W: 21.82 lbs 12 pcs

SPEAKERBUDS

2-in-1 true wireless stereo earbuds + built-in Bluetooth® speaker
 Écouteurs sans fil TWS 2-en-1 avec enceinte Bluetooth® intégrée

SPEAKERBUDS

Design by Alain Bertheau



AWARDS



reddot winner 2022



ÉCOUTEURS SANS FIL TWS



TWS EARBUDS

ENCEINTE PORTABLE



PORTABLE SPEAKER

DOUBLE MICROPHONE



DUAL MICROPHONE

RÉDUCTION DU BRUIT AMBIANT



ENVIRONMENT NOISE CANCELLING

JUSQU'À 24H D'AUTONOMIE



UP TO 24H PLAYTIME

RECHARGEABLE PAR USB-C



RECHARGEABLE VIA USB-C

FINITION CUIR SYNTHÉTIQUE



SYNTHETIC LEATHER FINISH



Écouteurs sans fil TWS 2-en-1 avec enceinte Bluetooth® intégrée - Double Microphone - Appels mains libres - Commandes vocales - Jusqu'à 6h de lecture musicale sur les écouteurs et 18h supplémentaires avec son étui de recharge - Rechargeable via USB-C (câble inclus) - Matériaux : ABS enveloppé de cuir synthétique.

2-in-1 True Wireless Stereo Earbuds with Bluetooth® speaker - Dual Microphone - Hands-free calls - Voice commands - Up to 6h music playtime on buds and an extra 18h with its charging case - Rechargeable via USB-C port (cable included) - Material: ABS wrapped with synthetic leather.

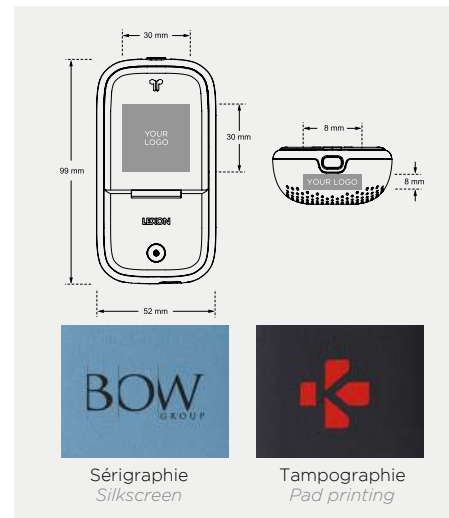

Produit : 9.9 x 5.2 x 2.5 cm
 Pack : 7.5 x 4 x 12.1 cm
 Carton : 27.5 x 46 x 20.5 cm

P. Net : 76 gr
 P. Brut : 120 gr
 P. Total : 7 kg

40 pcs

Product: 3.89 x 2.05 x 0.98" N.W: 0.17 lbs
 Pack: 2.95 x 1.57 x 4.76" G.W: 0.26 lbs
 Carton: 10.82 x 18.11 x 8.07" T.W: 15.42 lbs 40 pcs

LAMPS

LAMPES



NEW



NOVA COLLECTION



STELI COLLECTION

BEST SELLER



MINA COLLECTION



MIMI

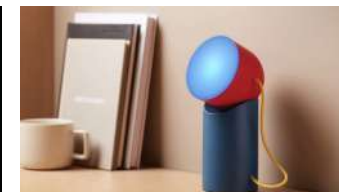

ORBE



LUMA COLLECTION



RAY LIGHT



BUBBLE LAMP



HORIZON
HANGING LAMP



BOLLA+



LANTERN



TERRACE+



NOVA S

Mini spherical LED Lamp (3.6 inches)
Mini lampe LED sphérique (8,8 cm)



LAMPE AVEC 9
COULEURS DE LED



LAMP WITH 9
COLORS

CONTRÔLE DE LA
LUMIÈRE PAR PRESSION



PUSH ACTIVATION
LIGHT

VARIATEUR
D'INTENSITÉ



DIMMER

JUSQU'À 12H
D'AUTONOMIE



UP TO 12H
BATTERY LIFE

RECHARGEABLE
PAR USB-C



RECHARGEABLE
VIA USB-C

ADAPTÉE À UN USAGE
EXTÉRIEUR (IPX4)



SUITABLE FOR
OUTDOOR USE (IPX4)

FINITION
ALUMINIUM



ALUMINIUM
FINISH

8,8 cm
3.46"



MAP



MD



DR



PU



MDB



MX

NOVA S

Design by Manuela Simonelli & Andrea Quaglio



Lampe LED synchronisable à l'infini - Lumière blanche froide ou chaude + 7 couleurs - Luminosité réglable par pression sur le dessus et 3 niveaux de luminosité prédéfinis via le bouton inférieur - Puissance lumineuse maximale : 30 lm - Variateur d'intensité - Contrôle tactile - Résistante à l'eau (IPX4) - Autonomie : Jusqu'à 12h (testée à 75% de luminosité) - Rechargeable par USB-C (câble inclus) - Temps de charge : 2h - Matériaux : Aluminium - ABS.

Infinitely synchronizable LED lamp - Cool or warm white light + 7 colors - Adjustable brightness by pushing on top and 3 preset brightness level on the bottom button - Maximum light output: 30 lm - Dimmer - Touch control - Water resistant (IPX4) - Battery life: Up to 12h (tested at 75% brightness) - Rechargeable via USB-C (cable included) - Charging time: 2h - Material: Aluminum - ABS.

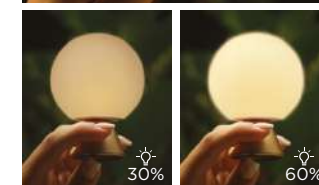
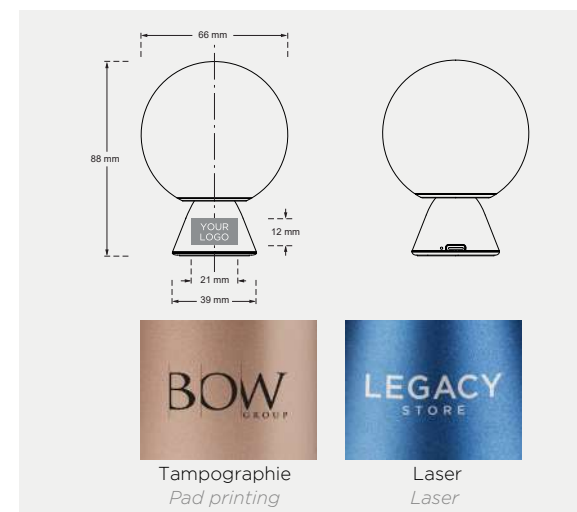

Produit : Ø6.6 x 8.8 cm
Pack : 10.4 x 8.2 x 11.6 cm
Carton : 47 x 45 x 27.5 cm

P. Net : 53 gr
P. Brut : 140 gr
P. Total : 7.3 kg

40 pcs

Product: Ø2.60 x 3.46"
Pack: 4.09 x 3.22 x 4.57"
Carton: 18.50 x 17.72 x 0.83"

N.W: 0.12 lbs
G.W: 0.31 lbs
T.W: 16.09 lbs

40 pcs

NOVA M

Medium spherical LED Lamp (5 inches)
Lampe sphérique LED medium (13 cm)



LAMPE AVEC 9
COULEURS DE LED



LAMP WITH 9 LED
COLORS

CONTRÔLE DE LA
LUMIÈRE PAR PRESSION



PUSH ACTIVATION
LIGHT

VARIATEUR
D'INTENSITÉ



DIMMER

JUSQU'À 12H
D'AUTONOMIE



UP TO 12H
BATTERY LIFE

WIRELESSLY
RECHARGEABLE & USB-C



WIRELESSLY
RECHARGEABLE & USB-C

ADAPTÉE À UN USAGE
EXTÉRIEUR (IPX4)



SUITABLE FOR
OUTDOOR USE (IPX4)

FINITION
ALUMINIUM



ALUMINIUM
FINISH



MAP



MD



DR



PU



MDB



MX

NOVA M

Design by Manuela Simonelli & Andrea Quaglio

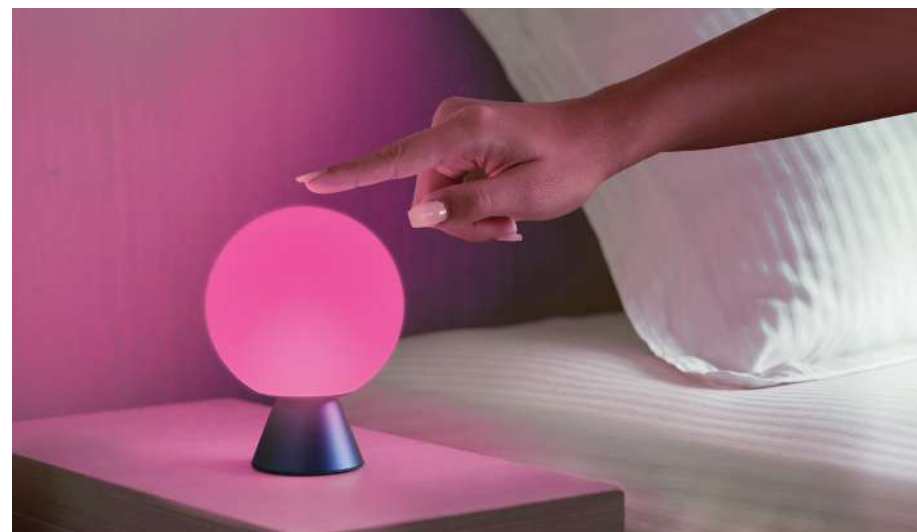

Lampe LED synchronisable à l'infini - Lumière blanche froide ou chaude + 7 couleurs - Luminosité réglable par pression sur le dessus et 3 niveaux de luminosité prédéfinis via le bouton inférieur - Puissance lumineuse maximale : 50 lm - Variateur d'intensité - Contrôle tactile - Résistante à l'eau (IPX4) - Autonomie : Jusqu'à 12h (testée à 75% de luminosité) - Rechargeable par USB-C (câble inclus) ou par induction - Temps de charge : 3h - Matériaux : Aluminium - ABS.

Infinitely synchronizable LED lamp - Cool or warm white light + 7 colors - Adjustable brightness by pushing on top and 3 preset brightness level on the bottom button - Maximum light output: 50 lm - Dimmer - Touch control - Water resistant (IPX4) - Battery life: Up to 12h (tested at 75% brightness) - Rechargeable via USB-C (cable included) or wirelessly - Charging time: 3h - Material: Aluminum - ABS.

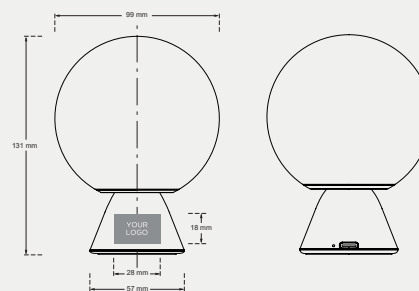

Tampographie
Pad printing



Laser
Laser



100%

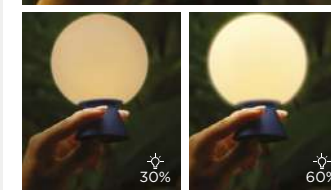

30%

60%

Produit : Ø9.9 x 13.1 cm
Pack : 13.4 x 10.6 x 16.9 cm
Carton : 60 x 58 x 43 cm

P. Net : 156 gr
P. Brut : 300 gr
P. Total : 15 kg 40 pcs

Product: Ø3.90 x 5.16"
Pack: 5.28 x 4.17 x 6.65"
Carton: 23.62 x 22.83 x 6.93"

N.W: 0.34 lbs
G.W: 0.66 lbs
T.W: 33.07 lbs 40 pcs

NOVA LSpherical LED Lamp (7.3 inches)
Lampe sphérique LED (18,6 cm)**NOVA L**

Design by Manuela Simonelli & Andrea Quaglio



Lampe LED synchronisable à l'infini - Lumière blanche froide ou chaude + 7 couleurs - Luminosité réglable par pression sur le dessus et 3 niveaux de luminosité prédéfinis via le bouton inférieur - Puissance lumineuse maximale : 80 lm - Variateur d'intensité - Contrôle tactile - Résistante à l'eau (IPX4) - Autonomie : Jusqu'à 12h (testée à 75% de luminosité) - Rechargeable par USB-C (câble inclus) ou par induction - Temps de charge : 4h - Matériaux : Aluminium - ABS.

Infinitely synchronizable LED lamp - Cool or warm white light + 7 colors - Adjustable brightness by pushing on top and 3 preset brightness level on the bottom button - Maximum light output: 80 lm - Dimmer - Touch control - Water resistant (IPX4) - Battery life: Up to 12h (tested at 75% brightness) - Rechargeable via USB-C (cable included) or wirelessly - Charging time: 4h - Material: Aluminum - ABS.

LAMP WITH 9
COULEURS DE LEDLAMP WITH 9
COLORSCONTRÔLE DE LA
LUMIÈRE PAR PRESSIONPUSH ACTIVATION
LIGHTVARIATEUR
D'INTENSITÉ

DIMMER

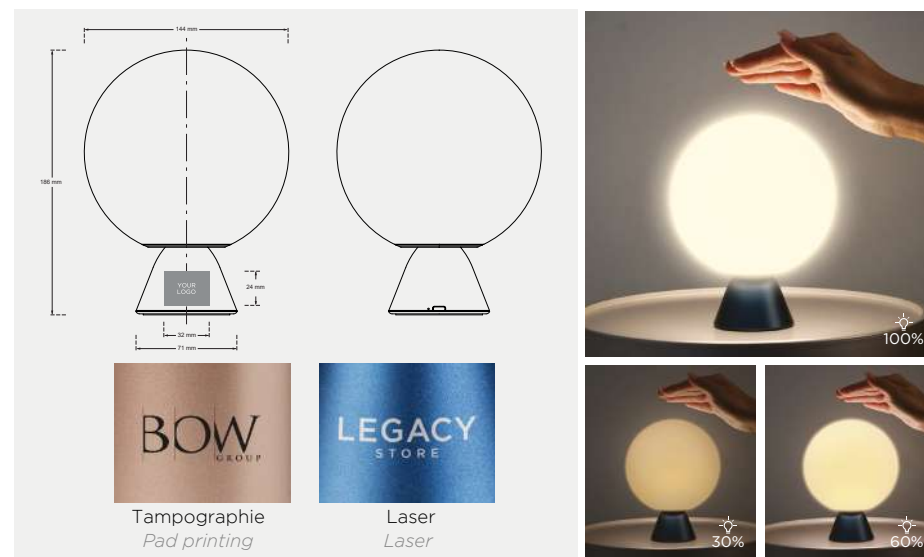
JUSQU'À 12H
D'AUTONOMIEUP TO 12H
BATTERY LIFEWIRELESSLY
RECHARGEABLE & USB-CWIRELESSLY
RECHARGEABLE & USB-CADAPTÉE À UN USAGE
EXTÉRIEUR (IPX4)SUITABLE FOR
OUTDOOR USE (IPX4)FINITION
ALUMINIUMALUMINIUM
FINISH

Produit : Ø14,4 x 18,6 cm P. Net : 297 gr
Pack : 20,5 x 16,7 x 23 cm P. Brut : 720 gr
Carton : 49 x 40 x 54 cm P. Total : 9,2 kg 12 pcs

Product: Ø5.67 x 7.32" N.W: 0.65 lbs
Pack: 8.07 x 6.57 x 9.05" G.W: 1.59 lbs
Carton: 19.29 x 15.75 x 21.26" T.W: 20.28 lbs 12 pcs



STELI S

Infinitely synchronizable candle LED lamp (8 inches)
Lampe de table synchronisable à l'infini (20 cm)



- LAMPE AVEC 9 COULEURS DE LED**



LAMP WITH 9 LED COLORS
- 100 LUMENS DE LUMINOSITÉ**



100 LUMENS BRIGHTNESS
- CONNECTABLE À L'INFINI**



INFINITELY PAIRABLE
- VARIATEUR D'INTENSITÉ**



DIMMER
- JUSQU'À 10H D'AUTONOMIE**



UP TO 10H BATTERY LIFE
- RECHARGEABLE PAR USB-C**



RECHARGEABLE VIA USB-C
- RECHARGEABLE PAR INDUCTION**



WIRELESSLY RECHARGEABLE
- ADAPTÉE À UN USAGE EXTÉRIEUR (IPX4)**



SUITABLE FOR OUTDOOR USE (IPX4)



STELI S

Design by Manuela Simonelli & Andrea Quaglio



Lampe de table synchronisable à l'infini - Lumière blanche froide ou chaude + 7 couleurs d'éclairage - Puissance lumineuse maximale : 100 lm - Variateur d'intensité - Commande tactile - Résistante à l'eau (IPX4) - Autonomie : Jusqu'à 10h (testée à 75% de luminosité) - Rechargeable par USB-C (câble inclus) ou par induction - Temps de charge : 3h - Matériaux : ABS.

Infinitely synchronizable table lamp - Cool or warm white light + 7 lighting colors - Maximum light output: 100 lm - Dimmer - Touch control - Water-resistant (IPX4) - Battery life: Up to 10h (tested at 75% brightness) - Rechargeable via USB-C (cable included) or wirelessly - Charging time: 3h - Material: ABS.

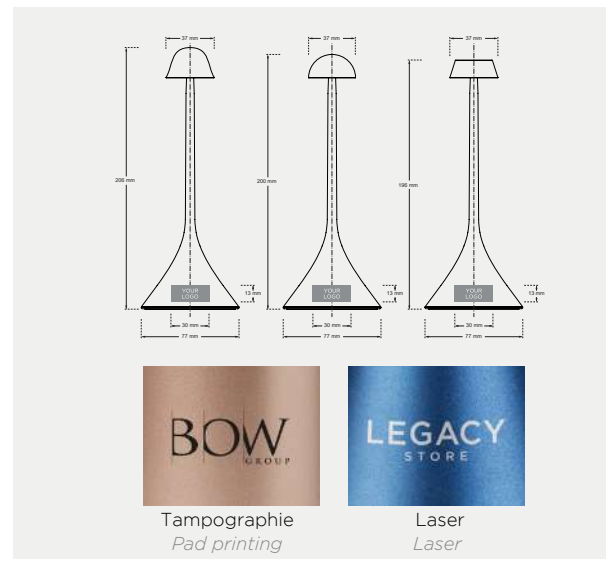

Produit :	Ø3.7 x 20 x Ø7.7 cm	P. Net :	190 gr	Product:	Ø1.46 x 7.87 x Ø3.03"	N.W.:	0.42 lbs
Pack :	11.6 x 9.5 x 25 cm	P. Brut :	395 gr	Pack :	4.57 x 3.74 x 9.84"	G.W.:	0.84 lbs
Carton :	49.8 x 48.6 x 28.1 cm	P. Total :	9.3 kg	Carton :	19.61 x 19.13 x 11.06"	T.W.:	20.50 lbs 20 pcs

STELI LOUNGE

Infinitely synchronizable table lamp (7 inches)
Lampe de table synchronisable à l'infini (20 cm)



AWARDS

reddot winner 2025

DESIGN AWARD 2025

GOOD DESIGN

- LAMPE AVEC 9 COULEURS DE LED

LAMP WITH 9 LED COLORS
- 150 LUMENS DE LUMINOSITÉ

150 LUMENS BRIGHTNESS
- CONNECTABLE À L'INFINI

INFINITELY PAIRABLE
- VARIATEUR D'INTENSITÉ

DIMMER
- JUSQU'À 10H D'AUTONOMIE

UP TO 10H BATTERY LIFE
- RECHARGEABLE PAR USB-C

RECHARGEABLE VIA USB-C
- RECHARGEABLE PAR INDUCTION

WIRELESSLY RECHARGEABLE
- ADAPTÉE À UN USAGE EXTÉRIEUR (IPX4)

SUITABLE FOR OUTDOOR USE (IPX4)
- FINITION ALUMINIUM

ALUMINUM FINISH



STELI LOUNGE

Design by Manuela Simonelli & Andrea Quaglio



Lampe de table synchronisable à l'infini - Lumière blanche froide ou chaude + 7 couleurs d'éclairage - Puissance lumineuse maximale : 150 lm - Variateur d'intensité - Commande tactile - Résistante à l'eau (IPX4) - Autonomie : Jusqu'à 10h (testée à 75% de luminosité) - Rechargeable par USB-C (câble inclus) ou par induction - Temps de charge : 4h - Matériaux : Aluminium - ABS.

Infinitely synchronizable table lamp - Cool or warm white light + 7 lighting colors - Maximum light output: 150 lm - Dimmer - Touch control - Water-resistant (IPX4) - Battery life: Up to 10h (tested at 75% brightness) - Rechargeable via USB-C (cable included) or wirelessly - Charging time: 4h - Material: Aluminum - ABS.



Produit :	Ø11.5 x 21.9 x Ø9.4 cm	P. Net :	380 gr	Product:	Ø4.53 x 8.62 x Ø3.70"	N.W:	0.84 lbs
Pack :	15.5 x 12.6 x 26.9 cm	P. Brut :	645 gr	Pack:	6.1 x 4.96 x 10.59"	G.W:	1.42 lbs
Carton :	65.8 x 32.8 x 30 cm	P. Total :	78 kg	Carton:	25.91 x 12.91 x 11.81"	T.W:	17.20 lbs 10 pcs

STELI CANDLE

Infinitely synchronisable candle LED lamp (11 inches)
Bougie LED infiniment synchronisable (27 cm)

AWARDS



reddot winner 2025



LAMPE AVEC 9
COULEURS DE LED



LAMP WITH 9 LED
COLORS

50 LUMENS
DE LUMINOSITÉ



50 LUMENS
BRIGHTNESS

CONNECTABLE
À L'INFINI



INFINITELY
PAIRABLE

VARIATEUR
D'INTENSITÉ



DIMMER

JUSQU'À 12H
D'AUTONOMIE



UP TO 12H
BATTERY LIFE

RECHARGEABLE
PAR USB-C



RECHARGEABLE
VIA USB-C

RECHARGEABLE
PAR INDUCTION



WIRELESSLY
RECHARGEABLE

ADAPTÉE À UN USAGE
EXTÉRIEUR (IPX4)



SUITABLE FOR
OUTDOOR USE (IPX4)

FINITION
ALUMINIUM



ALUMINUM
FINISH

27 cm
10.6"



D



AP



BZ



DR



DB



X

STELI CANDLE

Design by Manuela Simonelli & Andrea Quaglio



Bougie LED synchronisable à l'infini - Lumière blanche froide ou chaude + 7 couleurs d'éclairage - Puissance lumineuse maximale : 50 lm - Variateur d'intensité - Commande tactile - Résistante à l'eau (IPX4) - Autonomie : Jusqu'à 12h (testée à 75% de luminosité) - Rechargeable par USB-C (câble inclus) ou par induction - Temps de charge : 3h - Matériaux : Aluminium - ABS.

Infinitely synchronizable Candle LED lamp - Cool or warm white light + 7 lighting colors - Maximum light output: 40 lm - Dimmer - Touch control - Water-resistant (IPX4) - Battery life: Up to 12h (tested at 75% brightness) - Rechargeable via USB-C (cable included) or wirelessly - Charging time: 3h - Material: Aluminum - ABS.

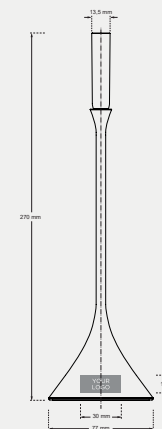

Tampographie
Pad printing

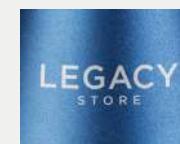

Laser
Laser



Produit : 27 x 77 cm
Pack : 11.6 x 9.5 x 25 cm
Carton : 49.5 x 49 x 36.3 cm

P. Net : 180 gr
P. Brut : 380 gr
P. Total : 10 kg 20 pcs

Product: 10.6" x 3.03"
Pack: 4.57 x 3.74 x 9.84"
Carton: 19.5 x 19.3 x 14.3"

N.W: 0.40 lbs
G.W: 0.84 lbs
T.W: 22.05 lbs 20 pcs

STELI

Infinitely synchronisable table lamp
Lampe de table synchronizable à l'infini

AWARDS



- LAMPE AVEC 9 COULEURS DE LED
- 120 LUMENS DE LUMINOSITÉ
- CONNECTABLE À L'INFINI
- VARIATEUR D'INTENSITÉ
- JUSQU'À 10H D'AUTONOMIE
- RECHARGEABLE PAR USB-C
- RECHARGEABLE PAR INDUCTION
- ADAPTÉE À UN USAGE EXTÉRIEUR (IPX4)
- FINITION ALUMINIUM



STELI

Design by Manuela Simonelli & Andrea Quaglio

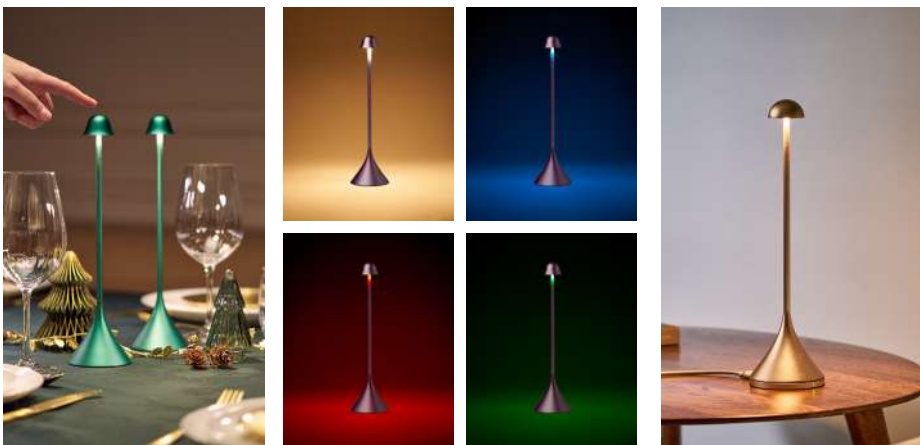

Lampe de table synchronisable à l'infini - Lumière blanche froide ou chaude + 7 couleurs d'éclairage - Puissance lumineuse maximale : 120 lm - Variateur d'intensité - Commande tactile - Résistante à l'eau (IPX4) - Autonomie : Jusqu'à 10h (testée à 75% de luminosité) - Rechargeable par USB-C (câble inclus) ou par induction - Temps de charge : 3h - Matériaux : Aluminium-ABS.

Infinitely synchronizable table lamp - Cool or warm white light + 7 lighting colors - Maximum light output: 120 lm - Dimmer - Touch control - Water-resistant (IPX4) - Battery life: Up to 10h (tested at 75% brightness) - Rechargeable via USB-C (cable included) or wirelessly - Charging time: 3h - Material: Aluminum - ABS.



Produit :	Ø3.7 x 28.6 x Ø7.7 cm	P. Net :	135 gr	N.W.:	0.29 lbs
Pack :	11.6 x 9.5 x 33.1 cm	P. Brut :	375 gr	G.W.:	0.83 lbs
Carton :	49.5 x 49 x 36.3 cm	P. Total :	8.5 kg	T.W.:	18.74 lbs

20 pcs



MINA

Mini LED lamp (3 inches) / Mini lampe LED (8 cm)



LUMIÈRE BLANCHE
CHAUDE OU FROIDE

WARM OR COLD
WHITE LIGHT

VARIATEUR
D'INTENSITÉ

DIMMER

JUSQU'À 12H
D'AUTONOMIE

UP TO 12H
BATTERY LIFE

RECHARGEABLE
PAR USB-C

RECHARGEABLE
VIA USB-C

FINITION
ALUMINIUM

ALUMINIUM
FINISH

8.3 cm
3.27"

ALU



GLOSSY

MINA

Design by Manuela Simonelli & Andrea Quaglio



Mini Lampe LED - Lumière blanche froide ou chaude - Puissance lumineuse maximale : 20 lm - Variateur d'intensité à mémoire - Autonomie : jusqu'à 12h (testée à 75% de luminosité, 22°C de température ambiante) - Temps de charge : 2h - Rechargeable par USB-C (câble inclus) - Matériaux : Aluminium - ABS.

Mini LED lamp - Cool or warm white light - Maximum light output: 20 lm - Memory dimmer - Battery life: up to 12h (tested at 75% brightness, 22°C ambient indoor temperature) - Charging time: 2h - Rechargeable via USB-C (cable included) - Material: Aluminum - ABS.



Produit : Ø7 x 8.3 cm
Pack : 10.2 x 8 x 11.5 cm
Carton : 43.4 x 42.7 x 26.5 cm
P. Net : 88 gr
P. Brut : 165 gr
P. Total : 76 gr
40 pcs



Product: Ø2.75 x 3.27"
Pack: 4.01 x 3.15 x 4.53"
Carton: 17.1 x 16.8 x 10.4"
N.W: 0.2 lbs
G.W: 0.36 lbs
T.W: 16.8 lbs
40 pcs

MINA M

Medium portable LED lamp (4 inches)
Lampe LED portable medium (11 cm)



MINA M

Design by Manuela Simonelli & Andrea Quaglio

- LAMPE AVEC 9 COULEURS DE LED**
LAMP WITH 9 LED COLORS
- VARIATEUR D'INTENSITÉ**
DIMMER
- JUSQU'À 24H D'AUTONOMIE**
UP TO 24H BATTERY LIFE
- PORT DE CHARGE USB-C**
USB-C CHARGING PORT
- RECHARGEABLE PAR INDUCTION**
WIRELESSLY RECHARGEABLE
- ADAPTÉE À UN USAGE EXTÉRIEUR (IPX4)**
SUITABLE FOR OUTDOOR USE (IPX4)
- FINITION ALUMINIUM**
ALUMINIUM FINISH



Lampe LED portable medium - Lumière blanche froide ou chaude +7 couleurs - Puissance lumineuse maximale : 40 lm - Contrôle de la lumière par pression - Variateur d'intensité - Résistance à l'eau IPX4 - Autonomie : jusqu'à 24h (testée à 75% de luminosité, 22°C de température ambiante) - Temps de charge : 2h - Rechargeable par USB-C (câble inclus) ou par induction - Matériaux : Aluminium - ABS.

Medium portable LED lamp - Cool or warm white light +7 colors - Maximum light output: 40 lm - Push activation light - Dimmer - Water resistant IPX4 - Battery life: up to 24h (tested at 75% brightness, 22°C ambient indoor temperature) - Charging time: 2h - Rechargeable via USB-C (cable included) or wirelessly - Material: Aluminum - ABS.

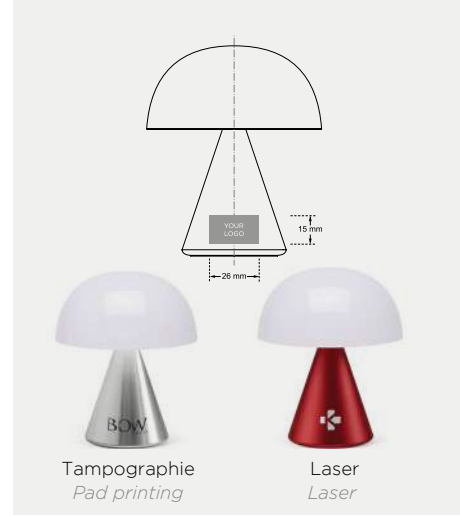

Produit :	Ø9.2 x 11 cm	P. Net :	142 gr
Pack :	12.3 x 9.5 x 12.3 cm	P. Brut :	354 gr
Carton :	52.8 x 50.5 x 32 cm	P. Total :	12.4 kg

Product:	Ø3.62 x 4.33"	N.W:	0.3 lbs
Pack:	4.84 x 3.74 x 4.84"	G.W:	0.77 lbs
Carton:	20.8 x 19.9 x 12.6"	T.W:	27.3 lbs

40 pcs

40 pcs

MINA L

Large portable LED lamp (7 inches) / Lampe LED portable large (17 cm)

MINA L

Design by Manuela Simonelli & Andrea Quaglio



- LAMPE AVEC 9 COULEURS DE LED**

LAMP WITH 9 COLORS
- VARIATEUR D'INTENSITÉ**

DIMMER
- JUSQU'À 24H D'AUTONOMIE**

UP TO 24H BATTERY LIFE
- PORT DE CHARGE USB-C**

USB-C CHARGING PORT
- RECHARGEABLE PAR INDUCTION**

WIRELESSLY RECHARGEABLE
- ADAPTÉE À UN USAGE EXTÉRIEUR (IPX4)**

SUITABLE FOR OUTDOOR USE (IPX4)
- FINITION ALUMINIUM**

ALUMINIUM FINISH



Lampe LED portable large - Lumière blanche froide ou chaude + 7 couleurs - Puissance lumineuse maximale : 65 lm - Contrôle de la lumière par pression - Variateur d'intensité - Résistance à l'eau IPX4 - Autonomie : jusqu'à 24h (testée à 75% de luminosité, 22°C de température ambiante) - Temps de charge : 3h - Rechargeable par USB-C (câble inclus) ou par induction - Matériaux : Aluminium - ABS.

Large portable LED lamp - Cool or warm white light + 7 colors - Maximum light output: 65 lm - Push activation light - Dimmer - Water resistant IPX4 - Battery life: up to 24h (tested at 75% brightness, 22°C ambient indoor temperature) - Charging time: 3h - Rechargeable via USB-C (cable included) or wirelessly - Material: Aluminum - ABS.



Produit : Ø14 x 17 cm
 Pack : 16 x 15 x 21.2 cm
 Carton : 47.9 x 34 x 45.5 cm

P. Net : 322 gr
 P. Brut : 614 gr
 P. Total : 8.4 kg

12 pcs

Product: Ø5.51 x 6.6"
 Pack: 6.29 x 5.9 x 8.34"
 Carton: 18.85 x 13.38 x 17.91"

N.W: 0.71 lbs
 G.W: 1.35 lbs
 T.W: 18.52 lbs

12 pcs

MINA L AUDIO

Portable LED lamp with 360° built-in Bluetooth® speaker
Lampe LED portable avec enceinte Bluetooth® à 360° intégrée

MINA L AUDIO

Design by Manuela Simonelli & Andrea Quaglio



AWARDS



- LAMPE AVEC 9 COULEURS DE LED**
 LAMP WITH 9 LED COLORS
- ENCEINTE BLUETOOTH**
 BLUETOOTH SPEAKER
- SON 360°**
 360° SOUND
- VARIATEUR D'INTENSITE**
 DIMMER
- JUSQU'À 24H D'AUTONOMIE**
 UP TO 24H BATTERY LIFE
- PORT DE CHARGE USB-C**
 USB-C CHARGING PORT
- RECHARGEABLE PAR INDUCTION**
 WIRELESSLY RECHARGEABLE
- FINITION ALUMINIUM**
 ALUMINIUM FINISH

Lampe LED audio portable large - Lumière blanche froide ou chaude + 7 couleurs - Puissance lumineuse maximale : 65 lm - Contrôle de la lumière par pression - Variateur d'intensité - Enceinte Bluetooth® 5W - Autonomie d'éclairage : jusqu'à 24h (testée à 75% de luminosité, 22°C de température ambiante) - Temps de charge : 3h - Rechargeable par USB-C (câble inclus) ou par induction - Matériaux : Aluminium - ABS.

Large portable audio LED lamp - Cool or warm white light + 7 colors - Maximum light output: 65 lm - Push activation light - Dimmer - Bluetooth® speaker - Light battery life: up to 24h (tested at 75% brightness, 22°C ambient indoor temperature) - Charging time: 3h - Rechargeable via USB-C (cable included) or wirelessly - Material: Aluminium - ABS.

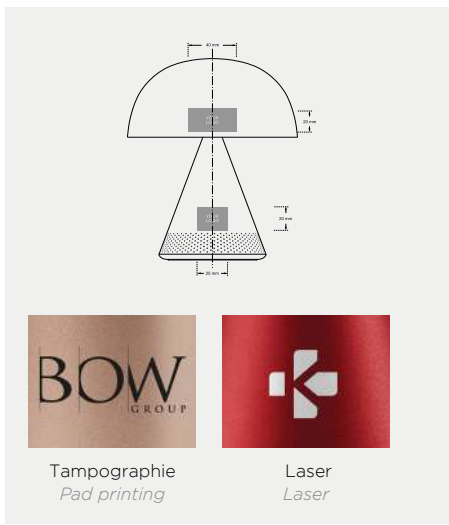

Produit : Ø14 x 17 cm
 Pack : 16 x 15 x 21.2 cm
 Carton : 47.9 x 34 x 45.5 cm

P. Net : 310 gr
 P. Brut : 600 gr
 P. Total : 8 kg

12 pcs

Product: Ø5.51 x 6.69"
 Pack: 6.29 x 5.9 x 8.34"
 Carton: 18.85 x 13.38 x 17.91"

N.W: 0.68 lbs
 G.W: 1.33 lbs
 T.W: 17.56 lbs

12 pcs

MIMI

Mini lampe LED flexible / Mini flexible LED lamp



MIMI

Design by Manuela Simonelli & Andrea Quaglio



AWARDS



reddot winner 2025



DESIGN AWARD 2025



LAMPE AVEC 9 COULEURS DE LED



LAMP WITH 9 LED COLORS

BRAS FLEXIBLE



FLEXIBLE ARM

CLIP INTÉGRÉ



BUILT-IN CLIP

VARIATEUR D'INTENSITÉ



DIMMER

JUSQU'À 12H D'AUTONOMIE



UP TO 12H BATTERY LIFE

RECHARGEABLE PAR USB-C



RECHARGEABLE VIA USB-C



Liseuse flexible avec clip - Angle réglable - Lumière blanche froide ou chaude + 7 couleurs - Variateur d'intensité - Puissance lumineuse maximale : 17 lm - Contrôle tactile - Autonomie : jusqu'à 12h (testé à 75% de luminosité) - Rechargeable par USB-C (câble inclus) - Temps de charge : 2h - Base livrée avec la lampe - Matériaux : Aluminium - ABS - Silicone.

Clip-on flexible reading lamp - Adjustable angle - Cool or warm white light + 7 colors - Maximum light output: 17 lm - Dimmer - Touch control - Battery life: Up to 12h (tested at 75% brightness) - Rechargeable via USB-C (cable included) - Charging time: 2h - Comes with a base - Material: Aluminum - ABS - Silicone.

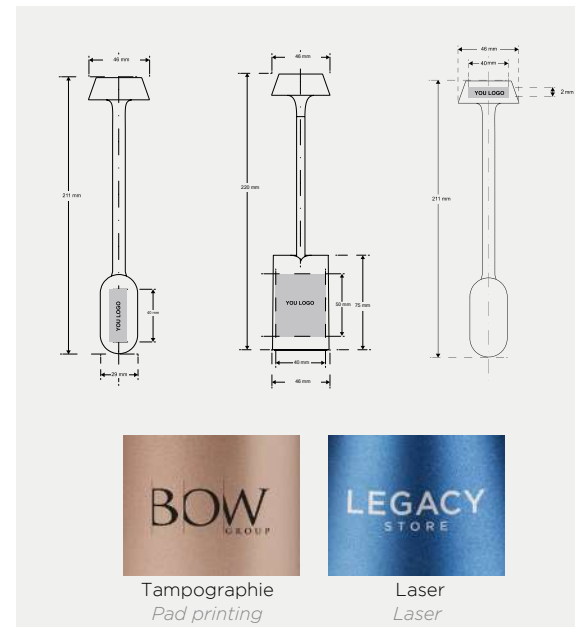

Produit : Ø4.6 x 22 cm
 Pack : 4.9 x 4.9 X 23 cm
 Carton : 45.2 x 27.5 x 26.5 cm

P. Net : 47 gr
 P. Brut : 123 gr
 P. Total : 9.3 kg

Product: Ø1.81 x 8.66"
 Pack: 1.93 x 1.93 X 9.05"
 Carton: 17.8 x 10.83 x 10.43"

N.W: 0.1 lbs
 G.W: 0.27 lbs
 T.W: 20.5 lbs

40 pcs

ORBE

Portable LED lamp with moving head
Lampe LED portable avec tête amovible



AWARDS

if DESIGN AWARD 2024

reddot winner 2023

GOOD DESIGN

- LAMPE AVEC 9 COULEURS DE LED**

LAMP WITH 9 LED COLORS
- 100 LUMENS DE LUMINOSITÉ**

100 LUMENS BRIGHTNESS
- TÊTE MAGNÉTIQUE ROTATIVE & DÉTACHABLE**

ROTATING & DETACHABLE MAGNETIC HEAD
- VARIATEUR D'INTENSITÉ**

DIMMER
- JUSQU'À 48H D'AUTONOMIE**

UP TO 48H BATTERY LIFE
- RECHARGEABLE PAR USB-C**

RECHARGEABLE VIA USB-C
- ADAPTÉE À UN USAGE EXTÉRIEUR (IPX4)**

SUITABLE FOR OUTDOOR USE (IPX4)



ORBE

Design by Nelson Fossey



Lampe LED portable avec tête rotative et amovible - 9 couleurs d'éclairage - Puissance lumineuse maximale : 100 lm - Variateur d'intensité - Jusqu'à 48 heures d'éclairage - Temps de charge : 5h - Rechargeable par USB-C - Convient pour une utilisation en extérieur (IPX4) - Matériaux : ABS - PP.

Portable LED lamp with moving and detachable head - 9 LED colors - Maximum light output: 100 lm - Dimmer - Up to 48 hours of illumination - Charging time: 5h - Rechargeable via USB-C - Suitable for outdoor use (IPX4) - Material: PP - ABS.

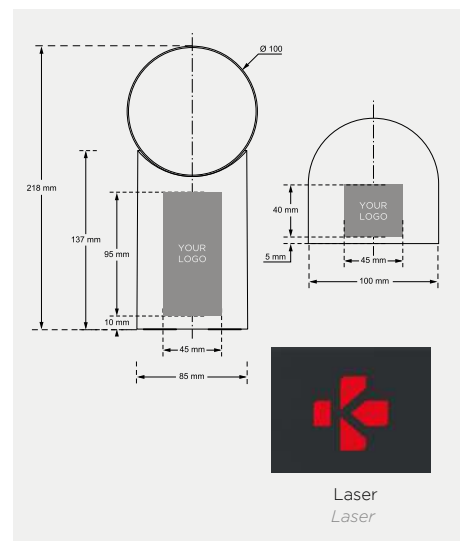

Produit :	Ø10 x 21.8 cm	P. Net :	532 gr	N.W.:	1.17 lbs
Pack :	13.5 x 11 x 26.8 cm	P. Brut :	800 gr	G.W.:	1.76 lbs
Carton :	46.5 x 41.8 x 29.5 cm	P. Total :	10 kg	T.W.:	22.04 lbs 12 pcs



LUMA S

Infinitely synchronizable LED lamp (3 inches)
Lampe LED synchronisable à l'infini (8 cm)



LAMPE AVEC 9
COULEURS DE LED



LAMP WITH 9 LED
COLORS

CONNECTABLE
À L'INFINI



INFINITELY
PAIRABLE

VARIATEUR
D'INTENSITÉ



DIMMER

JUSQU'À 12H
D'AUTONOMIE



UP TO 12H
BATTERY LIFE

PORT DE
CHARGE USB-C



USB-C
CHARGING PORT

ADAPTÉE À UN USAGE
EXTÉRIEUR (IPX4)



SUITABLE FOR
OUTDOOR USE (IPX4)

FINITION
ALUMINIUM



ALUMINIUM
FINISH

LUMA S

Design by Manuela Simonelli & Andrea Quaglio

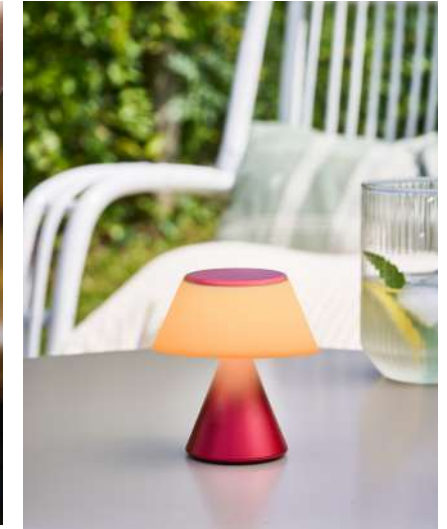

Lampe LED synchronisable à l'infini - Lumière blanche froide ou chaude + 7 couleurs - Puissance lumineuse maximale : 30 lm - Variateur d'intensité - Contrôle tactile - Résistante à l'eau (IPX4) - Autonomie : Jusqu'à 12h (testée à 75% de luminosité) - Rechargeable par USB-C (câble inclus) - Temps de charge : 2h - Matériaux : Aluminium - ABS.

Infinitely synchronizable LED lamp - Cool or warm white light + 7 colors - Maximum light output: 30 lm - Dimmer - Touch control - Water resistant (IPX4) - Battery life: Up to 12h (tested at 75% brightness) - Rechargeable via USB-C (cable included) - Charging time: 2h - Material: Aluminum - ABS.

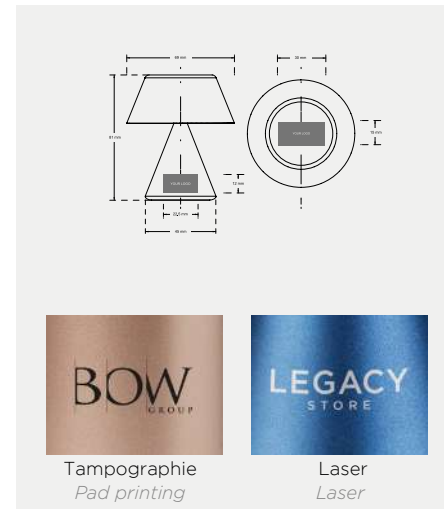

Produit : Ø6.9 x 8.1 cm
Pack : 10.4 x 8.2 x 11.6 cm
Carton : 43.4 x 42.7 x 26.5 cm

P. Net : 77 gr
P. Brut : 140 gr
P. Total : 7.8 kg

40 pcs

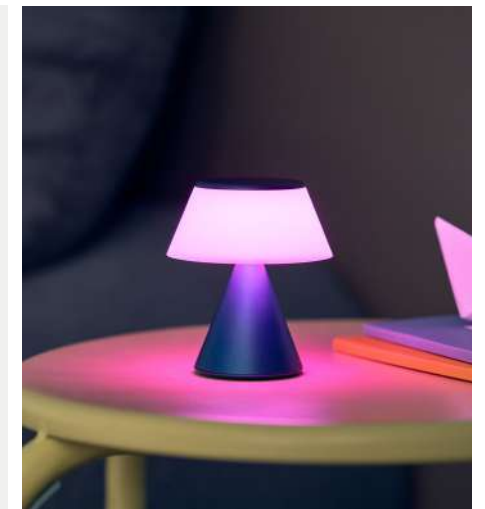

Product: Ø2.72 x 3.19"
Pack: 4.09 x 3.22 x 4.57"
Carton: 17.09 x 16.81 x 10.43"

N.W: 0.17 lbs
G.W: 0.31 lbs
T.W: 17.19 lbs

40 pcs

LUMA M

Infinitely synchronizable LED lamp (4 inches)
Lampe LED synchronisable à l'infini (11 cm)



- LAMPE AVEC 9 COULEURS DE LED**



LAMP WITH 9 LED COLORS
- CONNECTABLE À L'INFINI**



INFINITELY PAIRABLE
- VARIATEUR D'INTENSITÉ**



DIMMER
- JUSQU'À 12H D'AUTONOMIE**



UP TO 12H BATTERY LIFE
- PORT DE CHARGE USB-C**



USB-C CHARGING PORT
- RECHARGEABLE PAR INDUCTION**



WIRELESSLY RECHARGEABLE
- ADAPTÉE À UN USAGE EXTÉRIEUR (IPX4)**



SUITABLE FOR OUTDOOR USE (IPX4)
- FINITION ALUMINIUM**



ALUMINIUM FINISH



LUMA M

Design by Manuela Simonelli & Andrea Quaglio



Lampe LED synchronisable à l'infini - Lumière blanche froide ou chaude + 7 couleurs - Puissance lumineuse maximale : 45 lm - Variateur d'intensité - Contrôle tactile - Résistante à l'eau (IPX4) - Autonomie : Jusqu'à 12h (testée à 75% de luminosité) - Rechargeable par USB-C (câble inclus) ou par induction - Temps de charge : 3h - Matériaux : Aluminium - ABS.

Infinitely Synchronizable LED lamp - Cool or warm white light + 7 colors - Maximum light output: 45 lm - Dimmer - Touch control - Water resistant (IPX4) - Battery life: Up to 12h (tested at 75% brightness) - Rechargeable via USB-C (cable included) or wirelessly - Charging time: 3h - Material: Aluminum - ABS.



Produit : Ø9.3 x 10.8 cm
Pack : 12.2 x 9.8 x 13.8 cm
Carton : 51.5 x 26.5 x 30 cm

P. Net : 153 gr
P. Brut : 281 gr
P. Total : 6.5 kg

20 pcs



Product: Ø3.66 x 4.25"
Pack: 4.80 x 3.86 x 5.43"
Carton: 20.28 x 10.43 x 11.81"

N.W: 0.34 lbs
G.W: 0.62 lbs
T.W: 14.33 lbs

20 pcs

LUMA L

Infinitely synchronizable LED lamp (7 inches)
Lampe LED synchronisable à l'infini (18 cm)



- LAMPE AVEC 9 COULEURS DE LED**



LAMP WITH 9 LED COLORS
- 120 LUMENS DE LUMINOSITÉ**



120 LUMENS BRIGHTNESS
- CONNECTABLE À L'INFINI**



INFINITELY PAIRABLE
- VARIATEUR D'INTENSITÉ**



DIMMER
- JUSQU'À 12H D'AUTONOMIE**



UP TO 12H BATTERY LIFE
- PORT DE CHARGE USB-C**



USB-C CHARGING PORT
- RECHARGEABLE PAR INDUCTION**



WIRELESSLY RECHARGEABLE
- ADAPTÉE À UN USAGE EXTÉRIEUR (IPX4)**



SUITABLE FOR OUTDOOR USE (IPX4)
- FINITION ALUMINIUM**



ALUMINIUM FINISH



Colors on request / Couleurs sur demande

LUMA L

Design by Manuela Simonelli & Andrea Quaglio



Lampe LED synchronisable à l'infini - Lumière blanche froide ou chaude + 7 couleurs - Puissance lumineuse maximale : 150 lm - Variateur d'intensité - Contrôle tactile - Résistante à l'eau (IPX4) - Autonomie : Jusqu'à 12h (testée à 75% de luminosité) - Rechargeable par USB-C (câble inclus) ou par induction - Temps de charge : 4h - Matériaux : Aluminium - ABS.

Infinitely synchronizable LED lamp - Cool or warm white light + 7 colors - Maximum light output: 150 lm - Dimmer - Touch control - Water resistant (IPX4) - Battery life: Up to 12h (tested at 75% brightness) - Rechargeable via USB-C (cable included) or wirelessly - Charging time: 4h - Material: Aluminum - ABS.

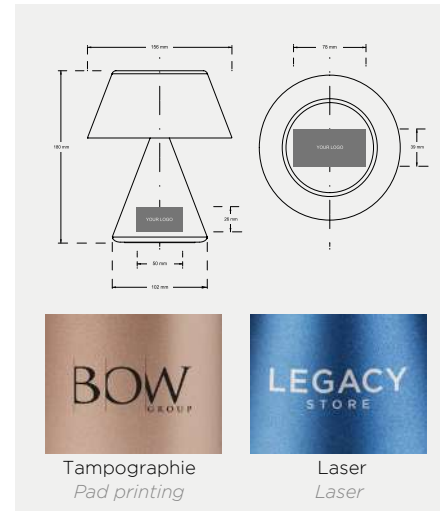

Produit : Ø15.6 x 18 cm
 Pack : 20.5 x 16.7 x 23 cm
 Carton : 52.2 x 42.8 x 49.5 cm

P. Net : 416 gr
 P. Brut : 720 gr
 P. Total : 11.2 kg

12 pcs



Product: Ø6.14 x 7"
 Pack: 8.07 x 6.57 x 9.05"
 Carton: 20.55 x 16.85 x 19.49"

N.W: 0.92 lbs
 G.W: 1.59 lbs
 T.W: 24.69 lbs

LUMA XL

Infinitely synchronizable LED lamp (12 inches)
Lampe LED synchronisable à l'infini (25 cm)

LUMA XL

Design by Manuela Simonelli & Andrea Quaglio



- LAMPE AVEC 9 COULEURS DE LED**
LAMP WITH 9 LED COLORS
- 200 LUMENS DE LUMINOSITÉ**
200 LUMENS BRIGHTNESS
- CONNECTABLE À L'INFINI**
INFINITELY PAIRABLE
- VARIATEUR D'INTENSITÉ**
DIMMER
- JUSQU'À 12H D'AUTONOMIE**
UP TO 12H BATTERY LIFE
- PORT DE CHARGE USB-C**
USB-C CHARGING PORT
- RECHARGEABLE PAR INDUCTION**
WIRELESSLY RECHARGEABLE
- ADAPTÉE À UN USAGE EXTÉRIEUR (IPX4)**
SUITABLE FOR OUTDOOR USE (IPX4)
- FINITION ALUMINIUM**
ALUMINIUM FINISH

Lampe LED synchronisable à l'infini - Lumière blanche froide ou chaude + 7 couleurs - Puissance lumineuse maximale : 200 lm - Variateur d'intensité - Contrôle tactile - Résistante à l'eau (IPX4) - Autonomie : Jusqu'à 12h (testée à 75% de luminosité) - Rechargeable par USB-C (câble inclus) ou par induction - Temps de charge : 4h - Matériaux : Aluminium - ABS.

Infinitely synchronizable LED lamp - Cool or warm white light + 7 colors - Maximum light output: 200 lm - Dimmer - Touch control - Water resistant (IPX4) - Battery life: Up to 12h (tested at 75% brightness) - Rechargeable via USB-C (cable included) or wirelessly - Charging time: 4h - Material: Aluminum - ABS.



Colors on request / Couleurs sur demande

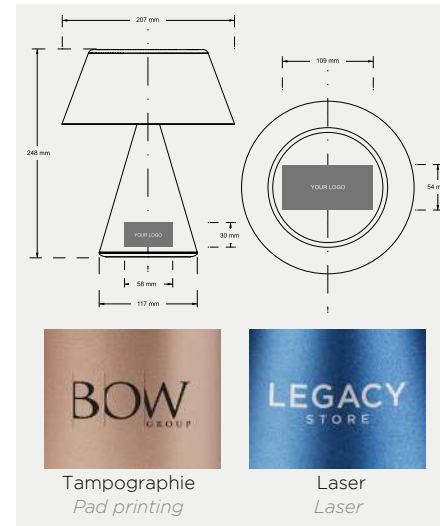

Produit : Ø20.7 x 24.8 cm
Pack : 29.1 x 21.6 x 33.8 cm
Carton : 60.5 x 46 x 37 cm

P. Net : 706 gr
P. Brut : 1.28 kg
P. Total : 7.3 kg

4 pcs

Product: Ø8.15 x 9.76" N.W.: 1.55 lbs
Pack: 11.46 x 8.50 x 13.30" G.W.: 2.82 lbs
Carton: 23.82 x 18.11 x 14.57" T.W.: 16.09 lbs 4 pcs

RAY LIGHT

Set of magnetic & synchronizable lamps
 Duo de lampes magnétiques et synchronisables à l'infini

RAY LIGHT

Design by neil poulton

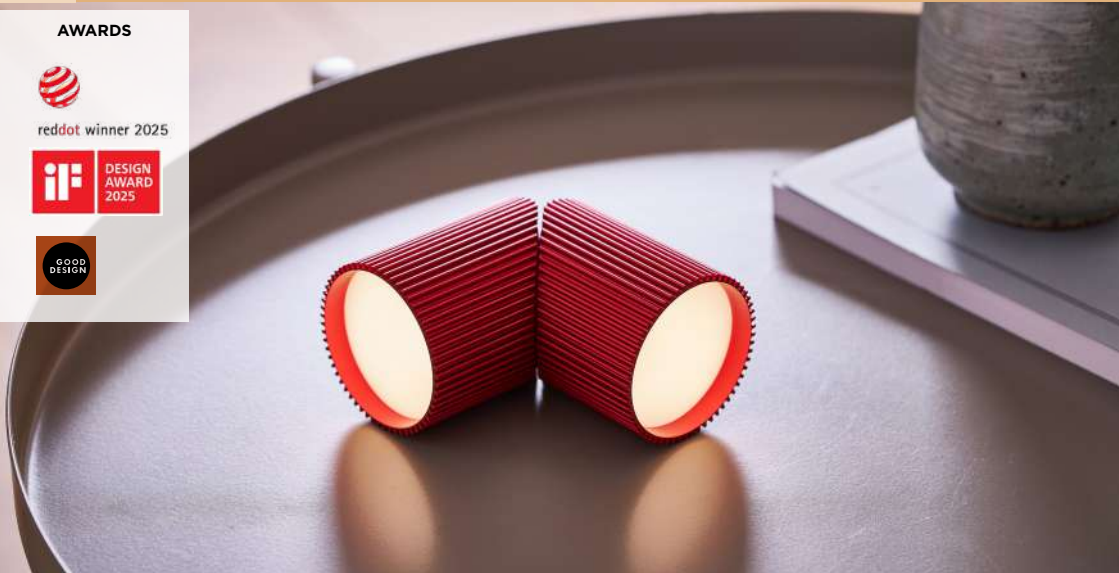

AWARDS

reddot winner 2025

DESIGN AWARD 2025

GOOD DESIGN

SET DE LAMPES AVEC 9 COULEURS DE LED



LAMP SET WITH 9 LED COLORS

CONNECTABLE À L'INFINI



INFINITELY PAIRABLE

FIXATION MAGNÉTIQUE



MAGNETIC ATTACHMENT

RECHARGEABLE PAR USB-C



RECHARGEABLE VIA USB-C

ADAPTÉE À UN USAGE EXTÉRIEUR (IPX4)



SUITABLE FOR OUTDOOR USE (IPX4)

FINITION ALUMINIUM



ALUMINUM FINISH



Duo de lampes magnétiques - Synchronisable à l'infini - Lumière blanche froide ou chaude + 7 couleurs - Puissance lumineuse maximale : 75 lm - Variateur d'intensité - Résistante à l'eau (IPX4) - Autonomie : Jusqu'à 6h - Rechargeable par USB-C (câble inclus) - Temps de charge : 2h - Matériaux : Aluminium - Métal magnétique - ABS - Silicone.

Set of magnetic lamps- Infinitely synchronizable - Cool or warm white light + 7 colors - Maximum light output: 75 lm - Dimmer - Water-resistant (IPX4) - Battery life: Up to 6h - Rechargeable via USB-C (cable included) - Charging time: 2h - Material: Aluminum - Magnetic metal - ABS - Silicone.



VG3



OB3



SR3



MN3

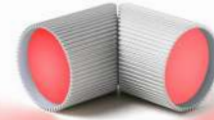

RA3

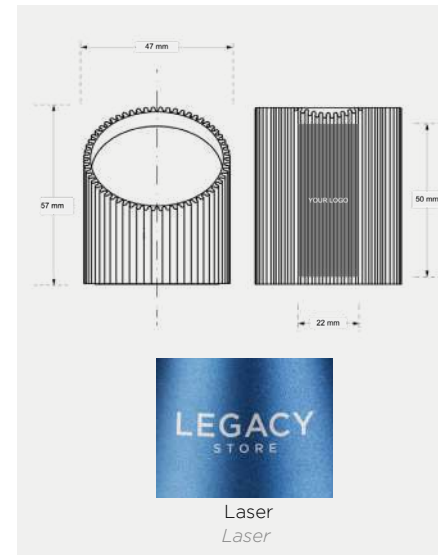

Produit : Ø4.8 x 5.7 cm
 Pack : 15.1 x 5.4 x 10.1 cm
 Carton : 56.7 x 31.8 x 23.4 cm

P. Net : 2x 90 gr
 P. Brut : 270 gr
 P. Total : 12 kg 40 pcs

Product: Ø1.89 x 2.24"
 Pack: 5.95 x 2.12 x 3.97"
 Carton: 22.32 x 12.52 x 9.21"

N.W: 2x 0.19 lbs
 G.W: 0.59 lbs
 T.W: 26.46 lbs 40 pcs

BUBBLE LAMP

Desk lamp with built-in wireless charger
 Lampe de bureau avec chargeur à induction intégré



- LAMPE AVEC 9 COULEURS DE LED



LAMP WITH 9 LED COLORS
- 150 LUMENS DE LUMINOSITÉ



150 LUMENS BRIGHTNESS
- DIFFUSEUR EN VERRE OPALE



FROSTED GLASS DIFFUSER
- VARIATEUR D'INTENSITÉ



DIMMER
- CHARGEUR À INDUCTION RAPIDE 15W



15W FAST WIRELESS CHARGER
- CERTIFIÉ Qi



Qi CERTIFIED
- JUSQU'À 6H D'AUTONOMIE



UP TO 6H BATTERY LIFE
- FINITION ALUMINIUM



ALUMINIUM FINISH



BUBBLE LAMP

Design by Alain Berteau



Lampe de bureau avec chargeur à induction intégré - Lumière blanche froide ou chaude + 7 couleurs d'éclairage - Puissance lumineuse maximale : 150 lm - Variateur d'intensité - Contrôle tactile - Compatible avec tous les appareils dotés de la technologie Qi - Autonomie : Jusqu'à 6h - Temps de charge : 3h - Double port USB-C pour charger et recharger - Matériaux : Aluminium - ABS - Verre.

Desk lamp with built-in wireless charger - Cold or warm white light + 7 lighting colors - Maximum light output: 150 lm - Dimmer - Touch control - Compatible with all Qi-enabled devices - Battery life: Up to 6 hours - Charging time: 3h - Dual USB-C port for charging and recharging - Material: Aluminum - ABS - Glass.

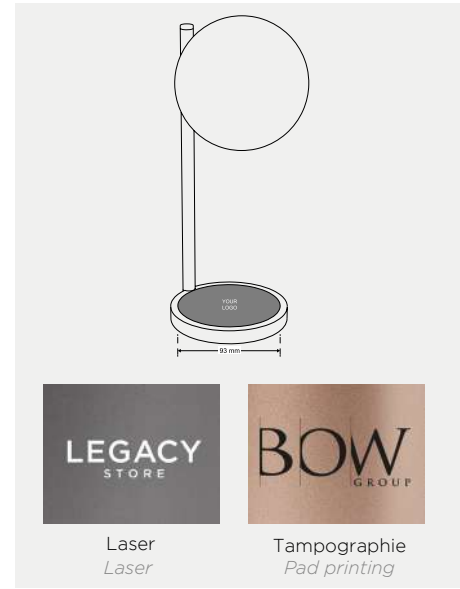

Produit :	Ø12 x 29,7 cm	P. Net :	473 gr	N.W.:	1,04 lbs
Pack :	18,3 x 15,1 x 34,8 cm	P. Brut :	813 gr	G.W.:	1,79 lbs
Carton :	62,7 x 38,5 x 38 cm	P. Total :	8,1 kg	T.W.:	17,86 lbs 8 pcs

Produit :	Ø4,72 x 11,69"	N.W.:	1,04 lbs
Pack :	7,20 x 5,94 x 13,70"	G.W.:	1,79 lbs
Carton :	24,68 x 15,16 x 14,96"	T.W.:	17,86 lbs 8 pcs

HORIZON HANGING LAMP

Multi-color outdoor LED lamp / Lampe portable d'extérieur à LED multicolore



- LAMPE AVEC 9 COULEURS DE LED**
 LAMP WITH 9 LED COLORS
- VARIATEUR D'INTENSITÉ**
 DIMMER
- CONTRÔLE TACTILE**
 TOUCH CONTROLS
- JUSQU'À 12H D'AUTONOMIE**
 UP TO 12H BATTERY LIFE
- RECHARGEABLE PAR USB-C**
 RECHARGEABLE VIA USB-C
- ADAPTÉE À UN USAGE EXTÉRIEUR (IPX4)**
 SUITABLE FOR OUTDOOR USE (IPX4)
- POIGNÉE EN ALUMINIUM**
 ALUMINUM HANDLE

HORIZON HANGING LAMP

Design by natacha.sacha.



Lampe LED nomade avec poignée - Lumière blanche froide ou chaude + 7 couleurs d'éclairage - Puissance lumineuse maximale : 65 lm - Contrôles tactiles - Variateur d'intensité - Résistance à l'eau IPX4 - Autonomie : jusqu'à 12h - Temps de charge : 3h - Rechargeable via USB-C (câble inclus) - Matériaux : Aluminium - ABS.

Hanging portable LED lamp - Cool or warm white light + 7 colors - Maximum light output: 65 lm - Touch activation light - Dimmer - Water resistant IPX4 - Battery life: up to 12h - Charging time: 3h - Rechargeable via USB-C port (cable included) - Material: Aluminum - ABS.

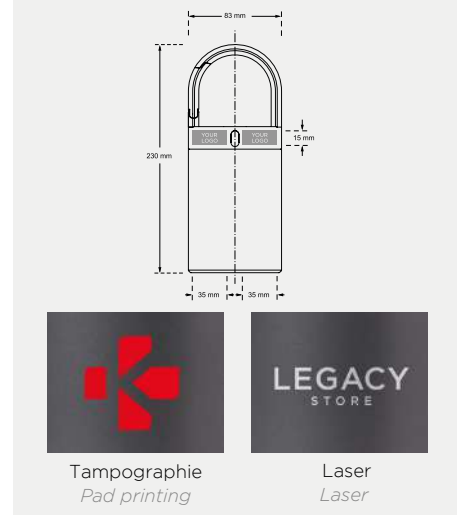

Produit : 9.4 x 7 x 22.9 cm
 Pack : 13.5 x 11.5 x 23.5 cm
 Carton : 49.6 x 42.7 x 26.2 cm

P. Net : 205 gr
 P. Brut : 350 gr
 P. Total : 6.35 kg

Product: 3.54 x 2.75 x 8.66"
 Pack: 5.12 x 4.33 x 9.05"
 Carton: 19.52 x 16.81 x 10.31"

N.W: 0.45 lbs
 G.W: 2.82 lbs
 T.W: 13.99 lbs

12 pcs

BOLLA+

Multi-color outdoor LED lamp / Lampe portable d'extérieur à LED multicolore

BOLLA+

Design by Claudio Gatto



- LAMPE AVEC 9 COULEURS DE LED**



LAMP WITH 9 LED COLORS
- VARIATEUR D'INTENSITÉ**



DIMMER
- JUSQU'À 8H D'AUTONOMIE**



UP TO 8H BATTERY LIFE
- RECHARGEABLE PAR USB-C**



RECHARGEABLE VIA USB-C
- ADAPTÉE À UN USAGE EXTÉRIEUR (IPX4)**



SUITABLE FOR OUTDOOR USE (IPX4)

Lampe LED multiposition - Usage intérieur/extérieur - Lumière blanche froide ou chaude + 7 couleurs - Puissance lumineuse maximale : 25 lm - Contrôle tactile - Mémoire de sauvegarde de la dernière couleur sélectionnée - Autonomie : jusqu'à 8h - Temps de charge : 2h - Rechargeable par USB-C (câble inclus) - Résistance à l'eau : IPX4 - Matériaux : Silicone - ABS.

Multi-position LED lamp - Indoor/outdoor use - Cool or warm white light + 7 colors - Maximum light output: 25 lm - Touch control - Backup memory of the last color selected - Battery life: up to 8h - Charging time: 2h - Rechargeable via USB-C (cable included) - Water resistance: IPX4 - Material: Silicone - ABS.



DB9

D9

W

N

X9

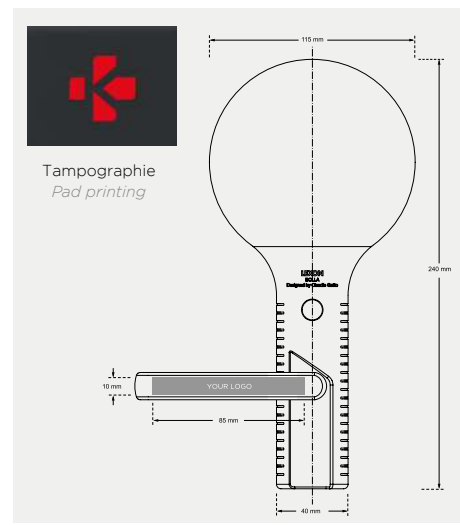

Produit : Ø11.5 x 28.2 cm
 Pack : 13.9 x 12.3 x 30.6 cm
 Carton : 65 x 31 x 68.5 cm

P. Net : 268 gr
 P. Brut : 318 gr
 P. Total : 11.6 kg

20 pcs

Product: Ø4.5 x 11.1"
 Pack: 5.47 x 4.84 x 12.05"
 Carton: 25.59 x 12.20 x 25.91"

N.W: 0.59 lbs
 G.W: 0.7 lbs
 T.W: 25.5 lbs

20 pcs

LANTERN

Portable lamp with built-in wireless charger
Lampe portable avec chargeur à induction intégré

LANTERN

Design by Alain Berteau



Un design contemporain pour un objet intemporel - Une solution d'éclairage LED élégante et contrôlée tactilement - Puissance lumineuse maximale : 100 lm - Un éclairage mobile intérieur et extérieur combiné à un chargeur par induction certifié Qi pour les appareils compatibles - Batterie intégrée de 5000 mAh et des LED RVB à 9 couleurs - Utilisable en extérieur classée IPX4 - Autonomie : 8h pour l'éclairage seul - Temps de charge: 4h - Connexion : USB-C (câble inclus) - Alimentation : il est recommandé d'utiliser l'adaptateur secteur Quick Charge 3.0 (non inclus) ou un adaptateur secteur DC 9 V/2 A (non inclus) - Matériaux : Cuir synthétique - ABS.

Contemporary design for a timeless object - Embedding elegant and touch-controlled LED lighting solution - Maximum light output: 100 lm - Offering outdoor and indoor mobile illumination combined with a Qi certified wireless charger for enabled devices - 5000 mAh built-in battery and 9 colors RGB LEDs - Outdoor friendly with IPX4 rating - Battery life: Up to 8h for lighting mode only - Charging time: 4h - Connection: USB-C (cable included) - Power supply: recommend to use with Quick Charge 3.0 Power Adapter (not included) or a DC 9V/2A power Adapter (not included) - Material: Synthetic leather - ABS.

AWARDS

if DESIGN AWARD 2024

GOOD DESIGN

reddot winner 2023

- LAMPE AVEC 9 COULEURS DE LED
- 100 LUMENS DE LUMINOSITÉ
- VARIATEUR D'INTENSITÉ
- CONTRÔLE TACTILE
- BATTERIE EXTERNE 5 000 mAh
- CHARGEUR À INDUCTION
- JUSQU'À 8H D'AUTONOMIE
- ADAPTÉE À UN USAGE EXTÉRIEUR (IPX4)

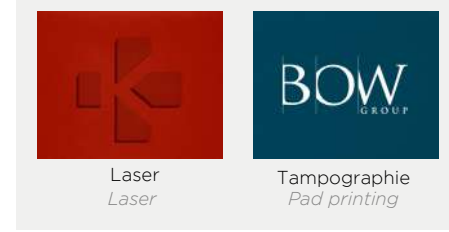
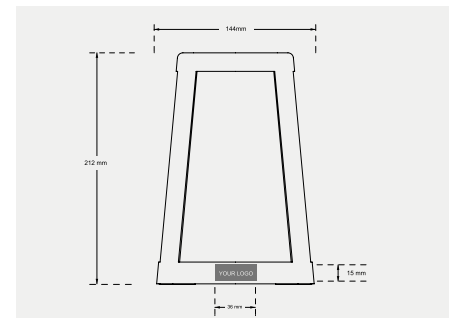

Produit :	14,4 x 14,4 x 21,2 cm	P. Net :	461 gr	N.W.:	1,01 lbs
Pack :	17,5 x 17,5 x 22,2 cm	P. Brut :	746 gr	G.W.:	1,64 lbs
Carton :	37,8 x 37,4 x 50 cm	P. Total :	7,3 kg	T.W.:	16,09 lbs

8 pcs

TERRACE+

3-in-1 LED lamp with built-in speaker & power bank
 Lampe LED 3-en-1 avec enceinte & batterie intégrées

TERRACE+

Design by Anne Klepper & Elise Berthier



Lampe LED 3-en-1 avec enceinte & batterie intégrées - Lumière blanche froide ou chaude + 9 programmes d'effets lumineux d'ambiance - Puissance lumineuse maximale : 150 lm - Variateur d'intensité - Contrôle tactile - Résistante à l'eau (IPX4) - Connecteur USB-C à double sens + port 2-USB A pour recharger n'importe quel appareil - Autonomie d'éclairage : jusqu'à 24h (testée à 75% de luminosité) - Rechargeable par USB-C (câble inclus) - Matériaux : Métal - ABS.

3-In-1 LED lamp with built-in speaker & power bank - Cool or warm white light + 9 special lighting effects - Special lighting effect - Maximum light output: 150 lm - Dimmer - Touch control - Water-resistant (IPX4) - Two-way USB-C connector + 2-USB A port for recharging any device - Light battery life: up to 24h (tested at 75% brightness) - Rechargeable via USB-C (cable included) - Material: Metal - ABS.

- LAMPE AVEC 9 COULEURS DE LED**

LAMP WITH 9 LED COLORS
- ENCEINTE BLUETOOTH***

BLUETOOTH* SPEAKER
- 150 LUMENS DE LUMINOSITÉ**

150 LUMENS BRIGHTNESS
- SON 360°**

360° SOUND
- VARIATEUR D'INTENSITÉ**

DIMMER
- BATTERIE EXTERNE 4 000 mAh**

4 000 mAh POWER BANK
- 2X PORTS USB-A POUR RECHARGER**

2X USB-A PORTS TO RECHARGE
- PORT USB-C POUR CHARGER ET RECHARGER**

TWO-WAY USB-C PORT TO RECHARGE
- ADAPTÉE À UN USAGE EXTÉRIEUR (IPX4)**

SUITABLE FOR OUTDOOR USE (IPX4)



22.6 cm
8.89"

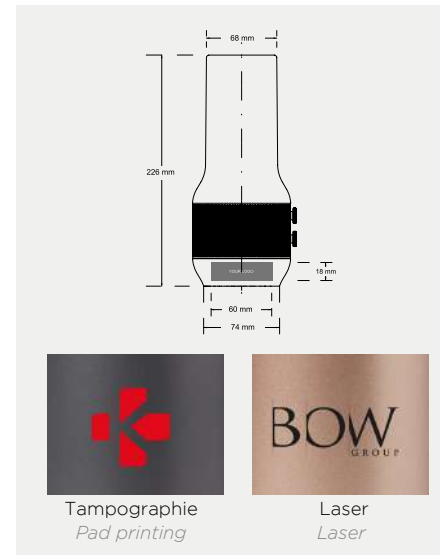

Tampographie
Pad printing



Laser
Laser



Produit : Ø10 x 22,6 cm
 Pack : 14,3 x 11,1 x 27,1 cm
 Carton : 47 x 45 x 30,2 cm

P. Net : 470 gr
 P. Brut : 705 gr
 P. Total : 9,7 kg

12 pcs

Product: Ø3.94 x 8.89"
 Pack: 5.63 x 4.37 x 10.55"
 Carton: 18.50 x 17.71 x 11.89"

N.W: 1.03 lbs
 G.W: 1.55 lbs
 T.W: 21.38 lbs

12 pcs

Color on request / Couleur sur demande

WELLNESS
BIEN-ÊTRE



MANO

**HORIZON
COLLECTION**

**OBLIO
COLLECTION**



THERMO BOTTLE



OBLIO



ROMINO



DIFFUSER



OBLIO BOX



UV STRAW



DISPENSER



**ZEN
COLLECTION**



PILLBOX



SAFETOUCH





HORIZON THERMO BOTTLE

Vacuum insulated stainless steel bottle (17 fl. oz)
Bouteille isotherme en acier inoxydable (500 ml)



- CAPACITÉ 500 ML**



17 FL. oz CAPACITY
- ISOLATION SOUS VIDE DOUBLE PAROI**



DOUBLE-WALL VACUUM INSULATION
- 24H FROID 12H CHAUD**



24H COLD 12H HOT
- ÉTANCHE**



LEAKPROOF
- MOUSQUETON INTÉGRÉ**



BUILT-IN CLIP
- ACIER INOXYDABLE 18/8**



18/8 STAINLESS STEEL
- SANS BPA**



BPA FREE
- POUR TOUTE BOISSON**



FOR ALL BEVERAGES

HORIZON THERMO BOTTLE

Design by natacha.sacha



Élégante bouteille à double isolation pour conserver votre liquide froid ou chaud pendant une longue période - Sans BPA - capacité 500 ml - Conserve les liquides chauds pendant 12 heures et les liquides froids pendant 24 heures - Matériaux : Acier inoxydable - ABS.

Elegant double insulated bottle for keeping your liquid cold or hot for long period - BPA-free - 500 ml / 16.9 oz capacity - Keep hot liquids for 12 hours and cold for 24 hours - Material: Stainless steel - ABS.



D O1 LBI X



Produit :	Ø7.6 x 24.5 cm	P. Net :	290 gr	Product:	Ø2.9 x 9.65"	N.W:	0.64 lbs
Pack :	8.5 x 7.5 x 24.8 cm	P. Brut :	420 gr	Pack:	3.35 x 2.95 x 9.76"	G.W:	0.93 lbs
Carton :	44 x 35 x 28.5 cm	P. Total :	9.15 kg	Carton:	17.32 x 13.78 x 11.22"	T.W:	20.17 lbs

20 pcs

HORIZON DIFFUSER

Aromatherapy humidifier and mist maker / Humidificateur et brumisateuse aromatherapique

HORIZON DIFFUSER

Design by natacha.sacha



DIFFUSION SILENCIEUSE
AVEC TECHNOLOGIE
ULTRASONIQUE



SILENT DIFFUSION
WITH ULTRASONIC
TECHNOLOGY

BRUME FRAÎCHE
INOFFENSIVE



COOL MIST SAFE
FOR USE

JUSQU'À 12H
D'AUTONOMIE



UP TO 12H
BATTERY LIFE

CAPACITÉ DU
RÉSERVOIR 1L



TANK CAPACITY
34 fl.oz

ARRÊT AUTOMATIQUE EN
CAS DE MANQUE D'EAU



AUTOMATIC SHUT-OFF
WHEN WATER TANK
IS EMPTY

RECHARGEABLE
PAR USB-C



RECHARGEABLE
VIA USB-C



D

O1

LBI

X



Diffuseur d'huiles essentielles et humidificateur à brume - 12h d'autonomie continue - capacité du réservoir 1 L - Cycle de diffusion réglable - arrêt automatique lorsque le réservoir d'eau est vide - Rechargeable par USB-C (câble inclus) - Matériaux : Aluminium/ABS.

Essential oil diffuser and mist humidifier - 12h continuous mist - 33 oz tank capacity - Adjustable diffusion cycle - waterless auto-off - Rechargeable via USB-C.(cable included - Material: Aluminum/ABS.

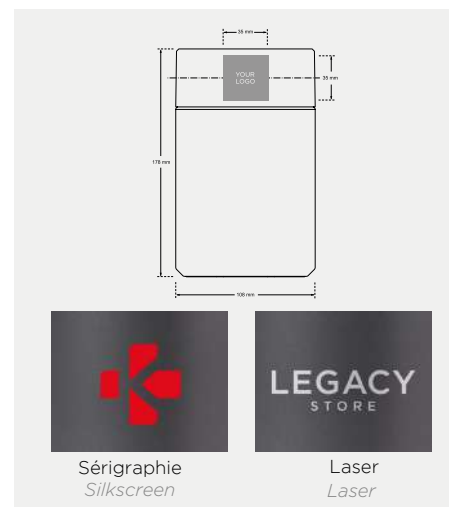

Sérigraphie
Silkscreen

Laser
Laser



Produit : Ø10.8 x 17.6 cm
Pack : 14.2 x 14.2 x 18.6 cm
Carton : 58.7 x 45 x 21.5 cm
P. Net : 360 gr
P. Brut : 530 gr
P. Total : 8 kg
12 pcs

Product: Ø4.25 x 6.95"
Pack: 5.59 x 5.59 x 7.32"
Carton: 23.11 x 17.71 x 8.47"
N.W: 0.79 lbs
G.W: 1.17 lbs
T.W: 17.86 lbs
12 pcs

HORIZON DISPENSER

Automatic gel or soap dispenser / Distributeur automatique de gel ou de savon



DISTRIBUTEUR DE GEL
SANS CONTACT



CONTACTLESS GEL
DISPENSER

DÉTECTION
AUTOMATIQUE DES MAINS



AUTOMATIC HAND
DETECTION

CAPACITÉ
400 ML



13.5 oz
CAPACITY

FONCTIONNE AVEC
DU SAVON LIQUIDE



WORKS WITH
LIQUID SOAP

JUSQU'À 6 MOIS
D'AUTONOMIE



UP TO 6 MONTHS
BATTERY LIFE

PORT DE
CHARGE USB-C



USB-C
CHARGING PORT



D



O1



LB1



X

HORIZON DISPENSER

Design by natacha.sacha



Distributeur automatique de gel ou de savon pour maison et bureau - Fonctionne avec du savon liquide - Batterie rechargeable intégrée - Grand réservoir d'une capacité de 400ml pour une utilisation quotidienne - Débit de la pompe réglable avec valve anti-goutte - Autonomie : 6 mois - Temps de charge: 4h - Rechargeable par USB-C (câble inclus) - Matériaux : Aluminium - ABS.

Home & office automatic gel or soap dispenser - Works with liquid soap - Built-in rechargeable battery - Large 400ml / 13.5oz tank capacity for daily usage - Adjustable pump flow with no-drip valve - Battery life: 6 month - Charging time: 4h - Rechargeable via USB-C (cable included) - Material: Aluminum - ABS.

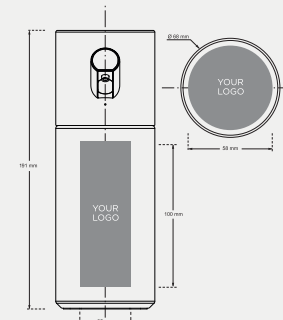

BOW
GROUP

Tampographie
Pad printing

LEGACY
STORE

Laser
Laser

Produit : Ø7.5 x 19.1 cm
Pack : 11 x 7.6 x 20.2 cm
Carton : 45.5 x 39.5 x 23 cm

P. Net : 195 gr
P. Brut : 380 gr
P. Total : 8 kg

20 pcs



Product: Ø2.95 x 7.5"
Pack: 4.33 x 2.99 x 7.95"
Carton: 17.91 x 15.55 x 9.05"

N.W: 0.43 lbs
G.W: 0.84 lbs
T.W: 18.08 lbs

20 pcs



NOMADAY PILLBOX

Travel pillbox with 7 compartments
Pillulier de voyage avec 7 compartiments



PILLULIER



PILLBOX

ADAPTÉE POUR
LE VOYAGESUITABLE
FOR TRAVEL7
COMPARTIMENTS7
COMPARTMENTS

SANS BPA



BPA FREE

FINITION
ALUMINIUMALUMINIUM
FINISH

DG1

DR

N

DB

D

X

NOMADAY PILLBOX

Design by Guillaume Delvigne



Pillulier semainier pour votre traitement ou garder vos médicaments toujours avec vous où que vous alliez - 7 compartiments pour votre prescription hebdomadaire ou simplement pour ranger certains de vos médicaments de base lors de vos voyages - Facile à nettoyer - Grands compartiments et finition de qualité supérieure - Matériaux : Aluminium - ABS.

Stylish pillbox to keep your treatment or essential medicines always with you wherever you go - 7 distinguished compartments for your weekly prescription or simply to store some of your basic medicines while traveling - Easy to clean inner material - Large compartments and premium finishing - Material: Aluminum - ABS.

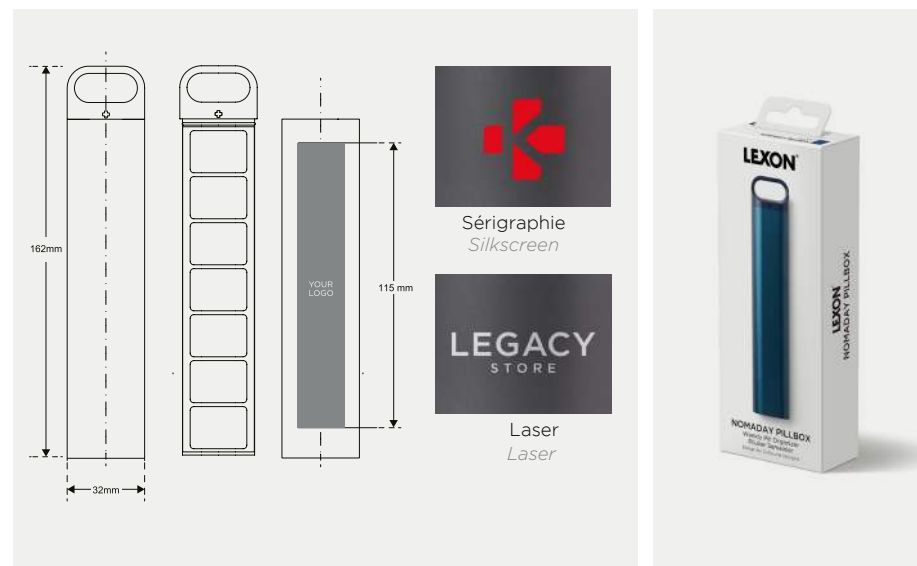

Produit : 3,2 x 1,8 x 16,4 cm
 Pack : 6,5 x 2,2 x 16,5 cm
 Carton : 28 x 23,9 x 19 cm

P. Net : 55 gr
 P. Brut : 82 gr
 P. Total : 3,7 kg

40 pcs

Produit : 1,26 x 0,70 x 6,45"
 Pack : 2,56 x 0,87 x 6,50"
 Carton : 11,02 x 9,41 x 7,48"

N.W : 0,12 lbs
 G.W : 0,18 lbs
 T.W : 8,16 lbs

40 pcs

NOMADAY UV STRAW

Reusable straw with UV-C sterilizing carrying case
Paille réutilisable avec étui de stérilisation UV-C



AWARD



reddot winner 2022



PAILLE RÉUTILISABLE



REUSABLE STRAW

ADAPTÉ POUR LE VOYAGE



SUITABLE FOR TRAVEL

LED UV ANTI-BACTÉRIENNE



ANTI-BACTERIAL UV LED

ÉLIMINE 99,9% DES BACTÉRIES



KILLS UP TO 99.9% OF BACTERIA

DÉSINFECTION AUTOMATIQUE ET COMPLÈTE EN 1 MIN



AUTOMATIC & FULL SANITIZING IN 1 MIN

RECHARGEABLE PAR USB-C



RECHARGEABLE VIA USB-C



DG1 DR N DB D X

Paille réutilisable en acier inoxydable avec étui de transport - Contribue à réduire l'utilisation de pailles jetables et à éviter les déchets plastiques - Solution de désinfection par UV-C validée par un laboratoire tiers avec une efficacité prouvée contre la plupart des bactéries et virus - Batterie rechargeable - 1x Brosse nettoyante (incluse) - Rechargeable par USB-C (câble inclus) - Matériaux : Aluminium - Acier inoxydable - ABS - Marquage conseillé : laser - tampographie.

Reusable stainless steel straw with UV-C - Helps reduce use of disposable straws and prevent plastic waste - UV-C sanitizing solution validated by third party laboratory with proven efficiency against most common bacteria and viruses - Rechargeable battery - 1x cleaning brush (included) - Rechargeable par USB-C (cable included) - Material: Aluminum - Stainless steel - ABS - Suggested branding: laser - pad print.

Produit :	Ø2.4 x 12.9 cm	P. Net :	45 gr	Product:	Ø0.94 x 5.08"	N.W:	0.1 lbs
Pack :	7 x 3 x 13.4 cm	P. Brut :	112 gr	Pack:	2.75 x 1.18 x 5.28"	G.W:	0.22 lbs
Carton :	44 x 31.5 x 15.6 cm	P. Total :	7.2 kg	Carton:	17.32 x 12.40 x 6.14"	T.W:	15.87 lbs
			60 pcs				60 pcs



HORIZON SAFETOUGH

Contactless door opener & keyring / *Porte-clés & ouvre-porte sans contact*
 Design by natacha.sacha



Crédit photo : @natacha.sacha.



D

O1

LB1

X

Porte-clés & ouvre-porte sans contact - Stilet en silicone antibactérien - Presse-bouton pour ascenseur/distributeur/interrupteur - Crochet pour ouverture ou fermeture de robinets et pousser ou tirer des poignées de portes - Passe-doigt résistant avec mousqueton intégré pour l'accrocher à vos clés - Matériaux : Aluminium - Silicone - Marquage conseillé : laser - tampographie.

Contactless key ring & door opener - Antibacterial silicone stylus - Button presser for lift/ATM machine/switch - Hook for opening or closing taps and pushing or pulling door handles - Strong finger loop with integrated carabiner for hanging on your keys - Material: Aluminum - Silicone - Suggested branding: laser - pad print.

Produit : 9 x 4 x 0.9 cm P. Net : 22 gr
 Pack : 6 x 2 x 10.7 cm P. Brut : 40 gr
 Carton : 33.5 x 23.5 x 26 cm P. Total : 4.4 kg 100 pcs

Product: 3.54 x 1.57 x 0.35" N.W: 0.05 lbs
 Pack: 2.36 x 0.79 x 3.94" G.W: 0.08 lbs
 Carton: 13.19 x 9.25 x 10.24" T.W: 9.7 lbs 100 pcs

MANO

Automatic liquid soap & hydroalcoholic gel dispenser with LED light
 Distributeur automatique de savon liquide et de gel hydroalcoolique avec lumière LED

MANO

Design by Manuela Simonelli & Andrea Quaglio



AWARDS



- DISTRIBUTEUR DE GEL SANS CONTACT**

CONTACTLESS GEL DISPENSER
- DÉTECTION AUTOMATIQUE DES MAINS**

AUTOMATIC HAND DETECTION
- LAMPE LED**

LED LIGHT
- CAPACITÉ 160ML**

5.4 oz CAPACITY
- DÉBIT DE POMPE RÉGLABLE**

ADJUSTABLE PUMP FLOW
- JUSQU'À 12 MOIS D'AUTONOMIE**

UP TO 12 MONTHS BATTERY LIFE
- RECHARGEABLE PAR USB-C**

RECHARGEABLE VIA USB-C

Distributeur automatique de savon liquide et de gel hydroalcoolique avec lumière LED - Détection automatique des mains - Anneau LED éclairé avec intensité réglable - Réservoir de gel rechargeable - Capacité de 160 ml - Valve anti-goutte - Contrôles tactiles : Éclairage d'ambiance LED (lumière blanche froide ou chaude) / Réglage de la luminosité (faible à élevée) / Débit de pompe réglable - Indicateur LED (statut de charge) - Rechargeable par USB-C (câble inclus) - Autonomie : jusqu'à 12 mois avec une utilisation quotidienne - Matériaux : ABS.

Automatic liquid soap & hydroalcoholic gel dispenser with LED light - Automatic hand detection - Embedded LED ring with adjustable brightness - Refillable gel tank capacity: 160ml / 5.4 oz - No-drip valve - Touch controls: Ambient LED lighting (cold or warm white light) / Adjustable brightness (low to high) / Adjustable pump flow - LED indicator (charging status) - Power supply: rechargeable via USB-C. (cable included) - Battery life : up to 12 months in daily use - Material: ABS.

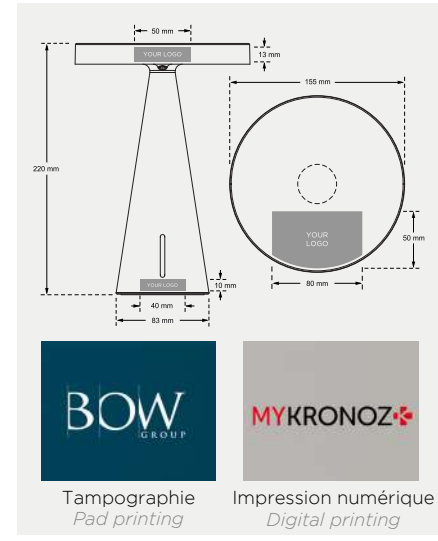

Produit :	Ø8.4 x Ø13.5 x 27 cm	P. Net :	340 gr	N.W. :	0.75 lbs
Pack :	17.5 x 17.5 x 24 cm	P. Brut :	870 gr	G.W. :	1.92 lbs
Carton :	62.2 x 42.1 x 26.3 cm	P. Total :	6.4 kg	T.W. :	14.11 lbs
			6 pcs		6 pcs

ROMINO

Compact waterless diffuser / Diffuseur compact sans eau

ROMINO

Design by Manuela Simonelli & Andrea Quaglio



AWARD



reddot winner 2023



DIFFUSEUR COMPACT ET SILENCIEUX



COMPACT & SILENT DIFFUSER

FONCTIONNE SANS EAU



WORKS WITHOUT WATER

ARRÊT AUTOMATIQUE TOUTES LES 2 HEURES



AUTOMATIC SHUT-OFF EVERY 2 HOURS

JUSQU'À 8H D'AUTONOMIE



UP TO 8H BATTERY LIFE

RECHARGEABLE PAR USB-C



RECHARGEABLE VIA USB-C



Élégant diffuseur d'arômes compact sans eau - Quelques gouttes d'huiles essentielles pour procurer du bien-être et un air agréable à respirer - Autonomie: 8h - Temps de charge: 2h - Rechargeable par USB-C (câble inclus) - Matériaux : Aluminium - ABS.

Elegant compact aroma diffuser without water - Few essential oils drops to provide wellness and good breathing air - Battery life: 8h - Charging time: 2h - Rechargeable via USB-C (cable included) - Material: Aluminum - ABS.



DG1

D

LP

X

LB1

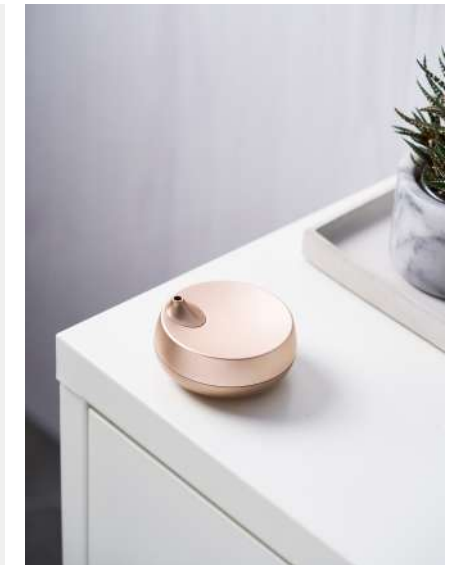
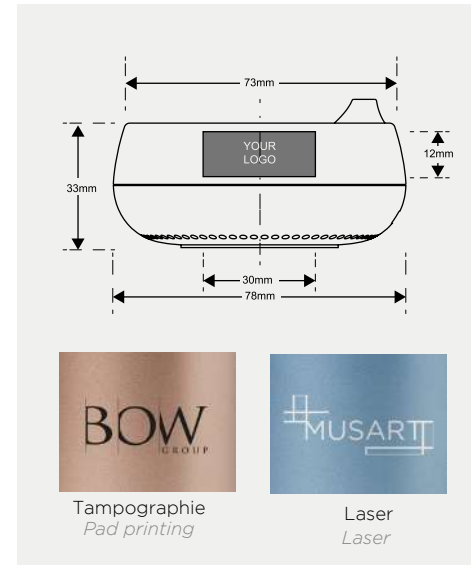

Produit :	Ø7.8 x 3.3 cm	P. Net :	83 gr
Pack :	8 x 5.4 x 8 cm	P. Brut :	148 gr
Carton :	34.3 x 29 x 18.8 cm	P. Total :	6.2 kg 40 pcs

Product:	Ø2.87 x 1.29"	N.W:	0.18 lbs
Pack:	3.15 x 2.12 x 3.15"	G.W:	0.33 lbs
Carton:	13.50 x 11.42 x 7.40"	T.W:	13.66 lbs 40 pcs



OBLIO

Wireless charging station with built-in UV-C sanitizer
Station de charge à induction avec stérilisateur UV-C intégré

OBLIO

Design by Manuela Simonelli & Andrea Quaglio



AWARDS

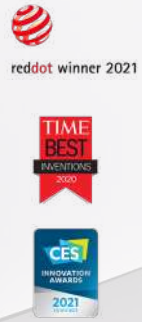

LED UV-C ANTIBACTÉRIENNE



ANTIBACTERIAL UV-C LED

ÉLIMINE 99.9% DES BACTÉRIES



KILLS UP TO 99.9% OF BACTERIA

DÉSINFECTION AUTOMATIQUE ET COMPLÈTE DE L'ÉCRAN EN 20 MIN



AUTOMATIC & FULL SCREEN SANITIZING IN 20 MIN

STATION DE CHARGE À INDUCTION



WIRELESS CHARGER

CHARGE RAPIDE 10W



10W FAST CHARGING

COMPATIBLE AVEC LES SMARTPHONES DOTÉS DE LA TECHNOLOGIE Qi



COMPATIBLE WITH Qi ENABLED SMARTPHONES



N



DB



D



Station de charge à induction 10W avec stérilisateur UV intégré - Certifié Qi - Charge rapide : environ 3h pour une charge complète du smartphone - Lampe UV-C antibactérienne - Élimine 99,9% des germes et bactéries sur l'écran de votre smartphone en 20 minutes - Retournez votre smartphone pour une désinfection complète à 360° - Testé en laboratoire contre les bactéries communes - Efficacité scientifiquement prouvée contre les virus dont le H1N1 - Cycle de désinfection automatique - Indicateur LED pour positionnement correct et statut de charge - Compatible avec les smartphones dotés de la technologie de charge Qi avec des dimensions allant jusqu'à 8,3 cm de largeur / 1,05 cm d'épaisseur, coque incluse (non métallique) - Détection d'objets étrangers - Rechargeable par USB-C (câble inclus) et sur adaptateur secteur certifié Quick Charge 3.0 ou un adaptateur secteur USB DC 9V/2A (non inclus) - Matériaux : ABS - Finition gomme.

10W Wireless charging station with built-in UV sanitizer - Qi-certified - Fast charging: approximately 3h required for a full smartphone charge - Antibacterial UV-C light - Eliminates 99.9% of germs and bacteria on your smartphone screen in 20 minutes - Flip your smartphone for a complete 360° disinfection - Laboratory tested against common bacteria - Scientifically proven to be effective against viruses including H1N1 - Automatic sanitizing cycle - LED indicator for proper placement and charging status - Compatible with Qi-enabled smartphones with size up to 8.3 cm wide / 1.05 cm thick including case (not metal) - Foreign object detection - Rechargeable via USB-C (cable included) and a Quick Charge 3.0 certified power adapter or a USB DC 9V/2A power adapter (not included) - Material: ABS - Rubber finish.

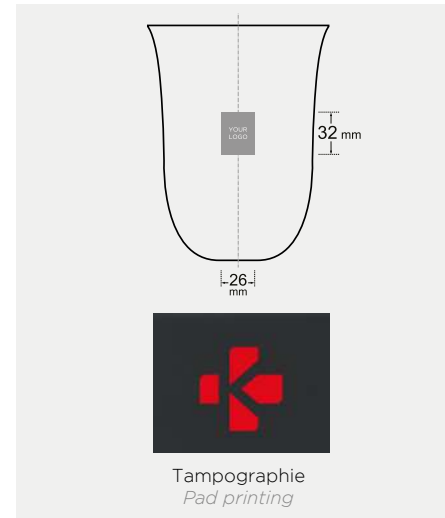

Produit : Ø7 x Ø13.6 x 17.5 cm P. Net : 435 gr
Pack : 16 x 16 x 21 cm P. Brut : 775 gr
Carton : 50 x 34 x 45 cm P. Total : 10.2 kg 12 pcs

Product: Ø2.7 x Ø5.35 x 6.89" N.W: 0.96 lbs
Pack: 6.29 x 6.29 x 8.26" G.W: 1.71 lbs
Carton: 19.69 x 13.38 x 17.71" T.W: 22.53 lbs 12 pcs

OBLIO BOX

Wireless charging station with built-in UV-C sanitizer
Station de charge à induction avec stérilisateur UV-C intégré



LED UV-C
ANTIBACTÉRIENNE



ANTIBACTERIAL
UV-C LED

ÉLIMINE 99.9%
DES BACTÉRIES



KILLS UP TO 99.9%
OF BACTERIA

DÉSINFECTION AUTOMATIQUE
ET COMPLÈTE EN 5 MIN



AUTOMATIC & FULL
SANITIZING IN 5 MIN

STATION DE CHARGE
À INDUCTION



WIRELESS
CHARGER

CHARGE
RAPIDE 10W



10W FAST
CHARGING

COMPATIBLE AVEC LES
APPAREILS DOTÉS DE LA
TECHNOLOGIE Qi



COMPATIBLE WITH Qi
ENABLED DEVICES



W



N

OBLIO BOX

Design by Manuela Simonelli & Andrea Quaglio



Boîtier de stérilisation UV-C avec chargeur à induction 10W - Certifié Qi - Charge rapide : environ 3h pour une charge complète du smartphone - Lampe UV-C antibactérienne - Élimine 99,9% des germes et bactéries sur votre smartphone en 5 minutes - Désinfectant UV : tout produit pouvant entrer dans le boîtier de stérilisation, comme les lunettes, montre, bijoux, écouteurs, masques, smartphones - Stérilisation UV à 360° - Testé en laboratoire contre les bactéries communes - Efficacité scientifiquement prouvée contre les virus dont le H1N1 - Cycle de désinfection automatique - Indicateur LED pour positionnement correct et statut de charge - Compatible avec la plupart des téléphones et appareils prenant en charge la charge à induction et compatibles Qi - Rechargeable par USB-C (câble inclus) et sur adaptateur secteur certifié Quick Charge 3.0 ou un adaptateur secteur USB DC 9V/2A (non inclus) - Matériaux : ABS.

UV-C sanitizer with built-in 10W wireless charger - Qi-certified - Fast charging: approximately 3h required for a full smartphone charge - Advanced anti-bacterial UV-C light - Eliminates 99.9% of your smartphone germs and bacteria in 5 minutes - UV sanitizer: any goods that can fit into the sanitizer, such as glasses, watch, jewelry, earphones, masks, smartphones - 360°UV sterilization - Cycle Laboratory tested against common bacteria - Scientifically proven to be effective against viruses including H1N1 - Unique and secured rotating closing cap - Automatic sanitizing cycle - LED indicator for proper placement and charging status - Compatible with most phones and devices that support wireless charging and are Qi-compatible - Foreign object detection - Rechargeable via USB-C (cable included) and a Quick Charge 3.0 certified power adapter or a USB DC 9V/2A power adapter (not included) - Material: ABS.

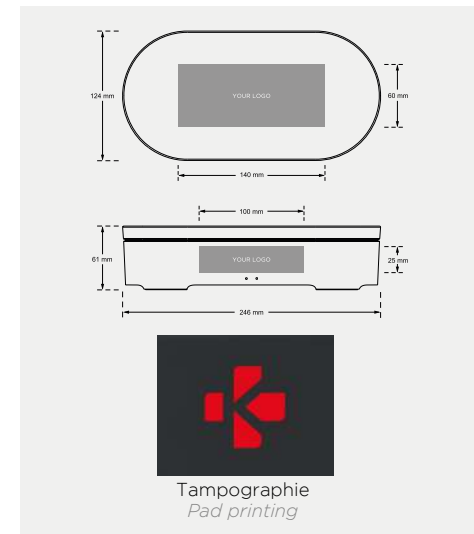

Produit : 24,6 x 12,4 x 6,1 cm
Pack : 27,5 x 8,4 x 15,2 cm
Carton : 56,5 x 26,7 x 33 cm

P. Net : 606 gr
P. Brut : 880 gr
P. Total : 11 kg

12 pcs

Product: 9.68 x 4.89 x 2.40"
Pack: 10.85 x 3.31 x 5.98"
Carton: 22.24 x 10.51 x 12.99"

N.W: 1.45 lbs
G.W: 1.94 lbs
T.W: 24.25 lbs

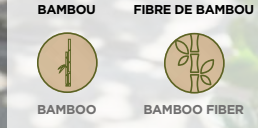

LH39 - ZEN CUP

LH40 - ZEN LARGE CUP

LH42 - ZEN COTTON BOX

LH43 - ZEN TISSUE BOX



W8



W8



W8



W8

Pot pour brosse à dents - 4 compartiments
Matériaux : bambou - fibre de bambou -
Marquage conseillé : sérigraphie

Rangement pour salle de bain -
4 compartiments - Matériaux : bambou - fibre de
bambou - Marquage conseillé : sérigraphie.

Boîtes de rangement pour salle de bain -
Pour coton, cotons-tiges, maquillage - Matériaux :
bambou - fibre de bambou - Marquage conseillé
: sérigraphie.

Boîte décorative pour mouchoirs en papier
- Matériaux : bambou - fibre de bambou -
Marquage conseillé : sérigraphie.

*Toothbrushcup - 4 compartments - Material:
bamboo / bamboo fiber - Suggested branding:
silkscreen.*

*Bathroom organizer - 4 compartments - Material:
bamboo / bamboo fiber - Suggested branding:
silkscreen.*

*Bathroom organizer boxes - For cotton, cottons
buds, make up - Material: bamboo / bamboo fiber
- Suggested branding: silkscreen.*

*Decorative tissue box - Material: bamboo /
bamboo fiber - Suggested branding: silkscreen.*

Produit :	8.4 x 8.4 x 10.5 cm	P. Net :	220 gr
Pack :	9 x 8.25 x 11.1 cm	P. Brut :	250 gr
Carton :	48 x 40 x 28 cm	P. Total :	10.84 kg 40 pcs

Produit :	21 x 8 x 9 cm	P. Net :	320 gr
Pack :	21.4 x 8.45 x 10.2 cm	P. Brut :	375 gr
Carton :	47 x 47 x 54 cm	P. Total :	17.56 kg 40 pcs

Produit :	15.4 x 8.4 x 9.4 cm	P. Net :	400 gr
Pack :	16.5 x 9 x 10.5 cm	P. Brut :	430 gr
Carton :	48 x 36 x 51 cm	P. Total :	19.22 kg 40 pcs

Produit :	26.5 x 13.7 x 8 cm	P. Net :	360 gr
Pack :	27 x 14.5 x 9 cm	P. Brut :	390 gr
Carton :	76 x 57 x 44 cm	P. Total :	24.8 kg 40 pcs

Product:	3.31 x 3.31 x 4.13"	N.W.:	0.48 lbs
Pack:	3.54 x 3.24 x 4.37"	G.W.:	0.55 lbs
Carton:	18.89 x 15.75 x 11.02"	T.W.:	23.9 lbs 40 pcs

Product:	8.26 x 3.14 x 3.54"	N.W.:	0.7 lbs
Pack:	8.42 x 3.33 x 4.01"	G.W.:	0.8 lbs
Carton:	18.5 x 18.5 x 21.26"	T.W.:	38.7 lbs 40 pcs

Product:	6 x 3.3 x 3.7"	N.W.:	0.88 lbs
Pack:	6.3 x 3.5 x 3.9"	G.W.:	0.95 lbs
Carton:	18.89 x 14.17 x 20.08"	T.W.:	42 lbs 40 pcs

Product:	10.43 x 5.39 x 3.14"	N.W.:	0.86 lbs
Pack:	10.63 x 5.71 x 3.54"	G.W.:	1.1 lbs
Carton:	29.92 x 22.44 x 17.3"	T.W.:	54.7 lbs 40 pcs

CHARGERS

CHARGEURS



POWERON



METALI-C



**SOFTPOWER
MAGBANK**



POWERUP



**SOFTPOWER
WIRELESSBANK**



POWERSOUND



OSLO ENERGY+



**FINE TUBE
POWER BANK 2**



**NOMADAY
POWER BANK**

POWERON

Dual USB wall fast charger - PD 30W
 Chargeur secteur rapide avec double port USB - PD 30W

POWERON

Design by LEXON Studio

AWARD



reddot winner 2023



PORT USB-C
+ PORT USB-A



USB-C PORT
+ USB-A PORT

TECHNOLOGIE DE CHARGE
RAPIDE POWER DELIVERY (30 W)



POWER DELIVER FAST CHARGING
TECHNOLOGY (30W)

CHARGE 2 APPAREILS
SIMULTANÉMENT



CHARGE 2 DEVICES
SIMULTANEOUSLY

ADAPTATEURS US + EU
INCLUS US + EU



US + EU PLUGS
INCLUDED

FORMAT
COMPACT



COMPACT
DESIGN

FINITION RÉSISSANTE
CUIR SYNTHÉTIQUE



DURABLE SYNTHETIC
LEATHER FINISH



Chargeur secteur rapide avec double port USB - 1 Port USB-C PD + 1 Port USB-A QC 3.0 - Technologie de charge rapide Power Delivery (PD) - Jusqu'à 30W de puissance - Capable de recharger jusqu'à 2 appareils simultanément - Prises US + EU incluses - Format compact - Finition premium en cuir synthétique - Matériaux : Cuir synthétique - ABS.

Dual USB wall fast charger - 1 USB-C PD port + 1 USB-A QC 3.0 port - Power Delivery fast charging technology (PD) - Up to 30W of power - Can charge up to 2 devices simultaneously - US + EU plugs included - Compact design - Premium synthetic leather finish - Materials: Synthetic leather - ABS.

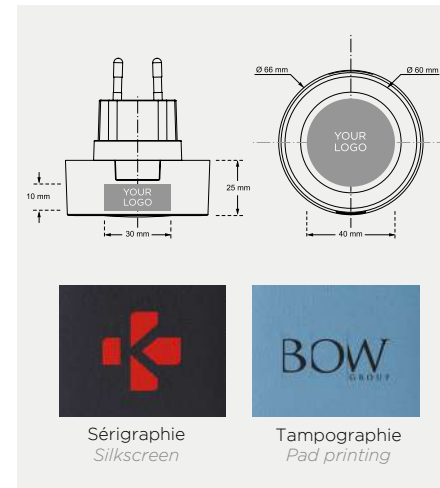

Produit : Ø6.6 x 2.5 cm
 Pack : 7.8 x 4.8 x 12 cm
 Carton : 33.5 x 26.5 x 27 cm

P. Net : 95 gr
 P. Brut : 157 gr
 P. Total : 6.9 kg 40 pcs

Product: Ø2.60 x 0.98" N.W: 0.2 lbs
 Pack: 3.07 x 1.89 x 4.72" G.W: 0.35 lbs
 Carton: 13.19 x 10.43 x 10.6" T.W: 15.21 lbs 40 pcs





METALI-C

USB-C cable / Câble USB-C

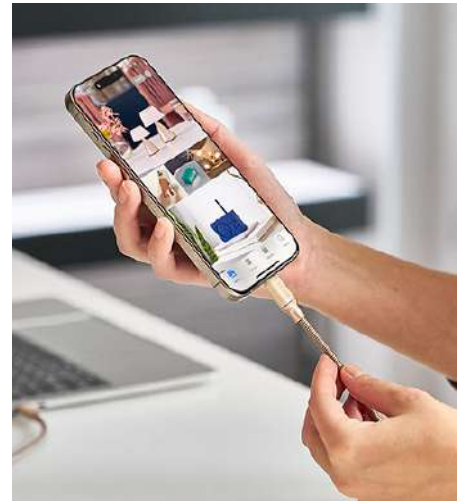
METALI-C

Design by LEXON Studio



<p>CÂBLE USB-C VERS USB-C</p>  <p>USB-C TO USB-C CABLE</p>	<p>1,5 m</p>  <p>5 FT</p>	<p>CHARGE RAPIDE JUSQU'À 100W</p>  <p>SUPPORTS FAST CHARGING UP TO 100W</p>	<p>HAUTE QUALITÉ ET DURABLE</p>  <p>HIGH-QUALITY & DURABLE</p>	<p>COMPATIBLE AVEC LA PLUPART DES APPAREILS MOBILES USB-C</p>  <p>COMPATIBLE WITH MOST USB-C MOBILE DEVICES</p>
--	---	---	--	---

Câble USB-C - Câble de haute qualité et durable de 1,5m - Fonction magnétique cachée - Compatible avec la plupart des smartphones, tablettes et ordinateurs portables USB-C - Prise en charge de la norme de charge rapide PD 100W. Sangle de fermeture magnétique customisable - Matériaux : Métal - Cuir synthétique - Marquage conseillé : laser - tampographie.

USB-C cable - High-quality & durable 1.5m / 5ft cable - Magnetic suction function - Compatible with most USB-C smartphones, tablets, and laptops - Support fast charging standard PD 100W. Customisable Magnetic synthetic leather closing strap - Material: Metal - Synthetic leather - Suggested branding: laser - pad print.

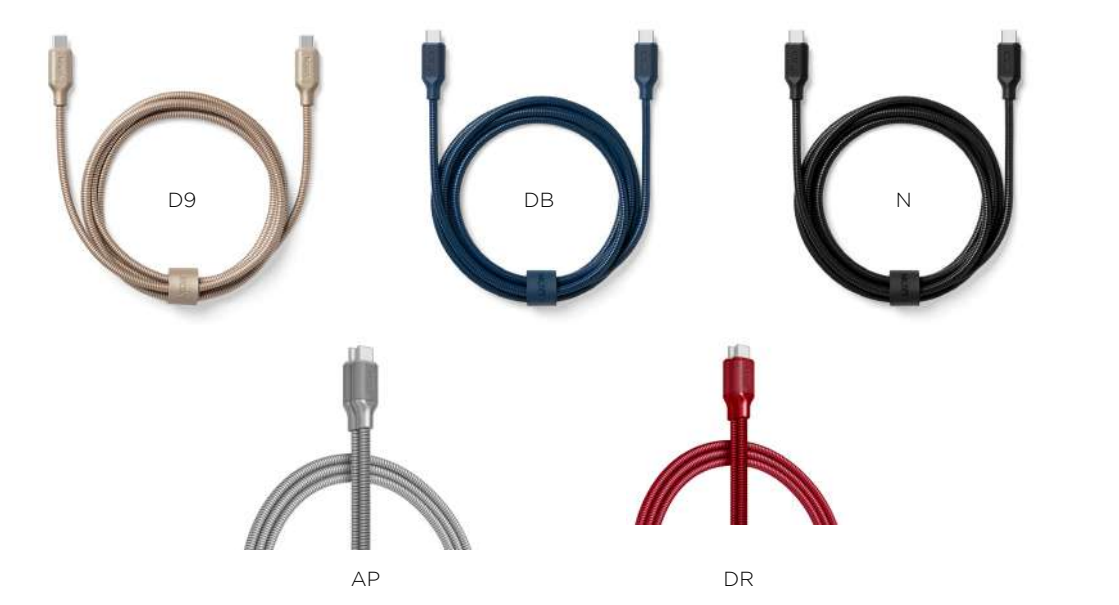

Produit : 1.5m
 Pack : 10 x 2.5 x 10 cm
 Carton : 32 x 28.5 x 23.5 cm
 P. Net : 75 gr
 P. Brut : 101 gr
 P. Total : 6.8 kg
 60 pcs

Product: 5 ft
 Pack: 3.94 x 0.98 x 3.94"
 Carton: 12.60 x 11.22 x 9.25"
 N.W: 0.16 lbs
 G.W: 0.22 lbs
 T.W: 15 lbs
 60 pcs

SOFTPOWER MAGBANK

Compact magnetic wireless power bank Magsafe compatible
 Batterie sans fil compacte & magnétique compatible Magsafe



- BATTERIE EXTERNE 3000 mAh**
 3000 mAh POWER BANK
- COMPATIBLE MAGSAFE (iPhone 12 et plus récent)**
 MAGSAFE COMPATIBLE (iPhone 12 and newer)
- CHARGEUR À INDUCTION CERTIFIÉ Qi**
 Qi-CERTIFIED WIRELESS CHARGER
- FONCTIONNE AVEC TOUS LES APPAREILS DOTÉS DE LA TECHNOLOGIE Qi**
 WORKS WITH ALL Qi ENABLED DEVICES
- FINITION RÉSISTANTE CUIR SYNTHÉTIQUE**
 DURABLE SYNTHETIC LEATHER FINISH
- PORT USB-C POUR CHARGER ET RECHARGER**
 TWO-WAY USB PORT TO CHARGE

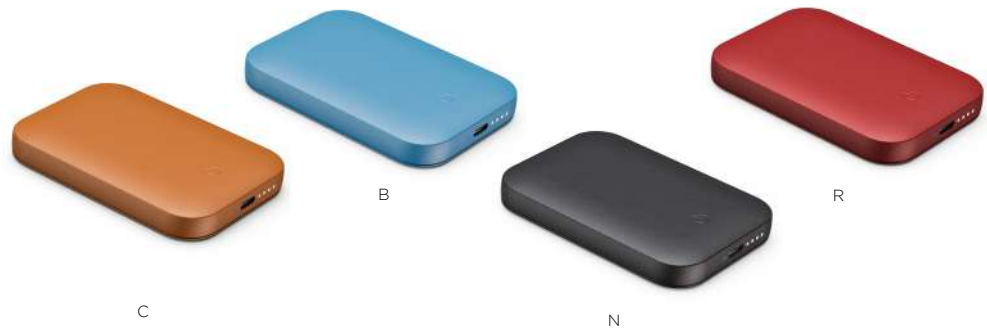

SOFTPOWER MAGBANK

Design by Alain Berteau



Batterie externe premium de 3000 mAh compatibles Magsafe (iPhone 12 et plus récent) avec connecteur Type-C à double sens - 5W en sortie de charge sans fil Qi et 15W via câble - Compatible avec tous les appareils Qi - Peut charger 2 appareils simultanément - Design compact et finition en cuir synthétique de qualité supérieure - Délivre une charge complète, varie selon le smartphone - Temps de charge : 2h - Rechargeable par USB-C (câble inclus) - Matériaux : Cuir synthétique - ABS.

Premium Magsafe compatible (iPhone 12 and newer) 3000 mAh powerbank with dual way Type-C connector - 5W Qi wireless charging output and up to 15W via cable - Compatible with any Qi devices - Can charge 2 devices simultaneously - Compact design and premium synthetic leather finishing - Delivers one full charge depending on smartphone - Charging time: 2h - Rechargeable via USB-C (cable included) - Material: Synthetic leather - ABS.







Produit :	9 x 1,2 x 6,2 cm	P. Net :	105 gr
Pack :	9,5 x 3 x 12,5 cm	P. Brut :	178 gr
Carton :	34,5 x 20,8 x 28 cm	P. Total :	71 kg 40 pcs

Product:	3.54 x 0.39 x 2.37"	N.W:	0.23 lbs
Pack:	3.74 x 1.18 x 4.923"	G.W:	0.39 lbs
Carton:	13.58 x 8.19 x 11.02"	T.W:	15.65 lbs 40 pcs

POWERUP
15W wireless charger
Chargeur à induction 15W

POWERUP
Design by LEXON Studio



<p>CHARGEUR À INDUCTION CERTIFIÉ Qi</p>  <p>Qi-CERTIFIED WIRELESS CHARGER</p>	<p>CHARGE RAPIDE 15W</p>  <p>15W FAST CHARGING</p>	<p>FONCTIONNE AVEC TOUS LES APPAREILS COMPATIBLES Qi</p>  <p>FONCTIONNE AVEC TOUS LES APPAREILS COMPATIBLES Qi</p>	<p>ULTRA FIN</p>  <p>EXTRA SLIM</p>	<p>CHARGEUR SECTEUR REQUIS</p>  <p>REQUIRES WALL CHARGER</p>	<p>FINITION CUIR SYNTHÉTIQUE ET ALUMINIUM</p>  <p>SYNTHETIC LEATHER & ALUMINIUM FINISH</p>
--	--	--	---	--	---



Chargeur sans fil 15W - Certifié Qi - Indicateur lumineux LED de chargement sans fil - Compatible avec tous les appareils compatibles Qi - Finition en cuir synthétique durable - Alimentation : utilisation recommandée par USB-C (câble inclus) et sur adaptateur secteur certifié Quick Charge 3.0 ou un adaptateur secteur USB DC 9V/2A (non inclus) - Matériaux : Cuir synthétique / Aluminium / ABS.

15W wireless charger - Qi certified - Wireless charging LED light indicator - Compatible with all Qi-enabled devices - Durable synthetic leather finishing - Power supply: recommend to use with Quick Charge 3.0 power adapter (not included) or a DC 9V/2 power adapter (not included) - Material: Synthetic leather / Aluminium / ABS.

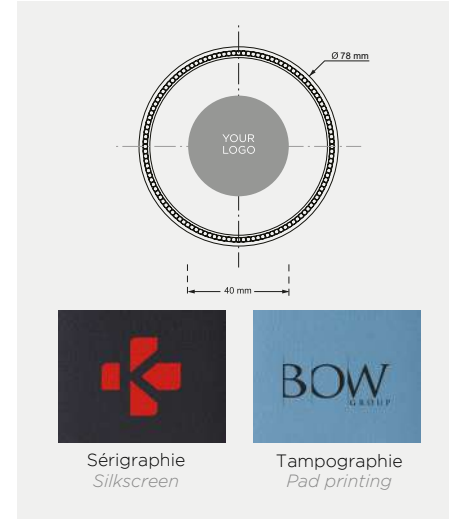

Produit : Ø7.8 x 0.6 cm
 Pack : 8 x 3 x 8 cm
 Carton : 42.40 x 19.80 x 19 cm

P. Net : 35 gr
 P. Brut : 70 gr
 P. Total : 9 kg

60 pcs

Product: Ø3.07 x 0.24"
 Pack: 3.15 x 1.18 x 3.15"
 Carton: 16.69 x 7.79 x 7.48"

N.W: 0.08 lbs
 G.W: 0.16 lbs
 T.W: 19.84 lbs

60 pcs

SOFTPOWER WIRELESSBANK

10 000 mAh power bank with built-in wireless charger
 Batterie externe 10 000 mAh avec chargeur à induction intégré



- BATTERIE EXTERNE
10000 mAh**



10 000 mAh
POWER BANK
- CHARGEUR À
INDUCTION CERTIFIÉ Qi**



Qi-CERTIFIED
WIRELESS CHARGER
- CHARGE RAPIDE
15W**



15W
FAST CHARGING
- FONCTIONNE AVEC TOUS
LES APPAREILS DOTÉS
DE LA TECHNOLOGIE Qi**



WORKS WITH
ALL Qi ENABLED
DEVICES
- FINITION RÉSIDANTE
CUIR SYNTHÉTIQUE**



DURABLE SYNTHETIC
LEATHER FINISH
- PORT USB-C POUR
CHARGER ET
RECHARGER**



TWO-WAY USB
PORT TO CHARGE
& RECHARGE

SOFTPOWER WIRELESSBANK

Design by Alain Berteau



Batterie externe 10 000 mAh avec chargeur à induction certifié Qi - Charge rapide 15W : environ 3h pour une charge complète du smartphone - Compatible avec tous les appareils Qi - Port USB-C bidirectionnel pour charger et se recharger (câble inclus) - Matériaux : ABS - PC enveloppé de cuir synthétique.

10 000 mAh power bank with Qi certified wireless charger - 15W fast charging: approx 3h for a full smartphone charge - Compatible with all Qi enabled devices - Dual way USB-C connector for charging and recharging (cable included) - Material: ABS - PC wrapped with synthetic leather.

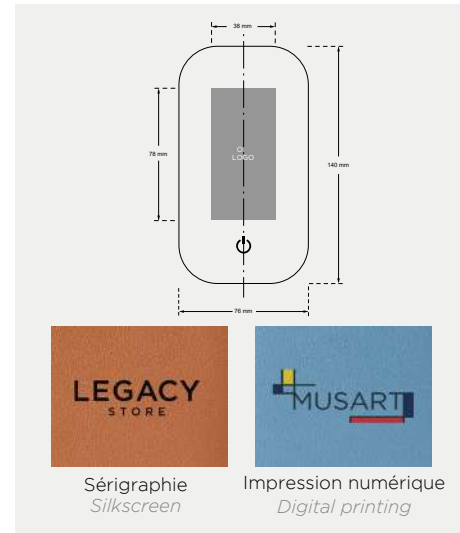

Produit :	14 x 7,6 x 1,74 cm	P. Net :	232 gr
Pack :	10 x 3 x 14,5 cm	P. Brut :	292 gr
Carton :	34 x 22,5 x 17,5 cm	P. Total :	6,9 kg



Product:	5.5 x 2.99 x 0.685"	N.W:	0.51 lbs
Pack:	3.94 x 1.18 x 5.71"	G.W:	0.64 lbs
Carton:	13.38 x 8.86 x 6.89"	T.W:	15.21 lbs

20 pcs

POWERSOUND

5 000 mAh wireless power bank with Bluetooth® speaker
 Batterie externe 5 000 mAh avec chargeur à induction & enceinte Bluetooth® intégrée

POWERSOUND

Design by Alain Berteau



AWARDS



- CHARGEUR À INDUCTION Qi 5000 mAh**



5 000 mAh Qi WIRELESS CHARGER
- FONCTIONNE AVEC TOUS LES APPAREILS DOTÉS DE LA TECHNOLOGIE Qi**



WORKS WITH ALL Qi ENABLED DEVICES
- ENCEINTE BLUETOOTH® 5W**



5W BLUETOOTH® SPEAKER
- JUSQU'À 20H D'AUTONOMIE**



UP TO 20H PLAYTIME
- RECHARGE ET CHARGE SANS FIL**



SOLELY WIRELESS CHARGING AND RECHARGING
- FINITION RÉSISTANTE CUIR SYNTHÉTIQUE**



DURABLE SYNTHETIC LEATHER FINISH



Batterie externe 5 000 mAh et chargeur à induction Qi avec enceinte Bluetooth® intégrée - Chargeur à induction 5W - Compatible avec tous les appareils dotés de la technologie de charge Qi - Enceinte Bluetooth® 3W - Autonomie : jusqu'à 20h - Se recharge et charge par induction, entièrement sans fil - Matériaux : ABS enveloppé de cuir synthétique.

5 000 mAh Qi wireless power bank with Bluetooth® speaker - 5W wireless charger - Compatible with all Qi enabled devices - 3W Bluetooth® speaker - Playtime: up to 20h - Solely wireless charging and recharging - Material: ABS wrapped with synthetic leather.

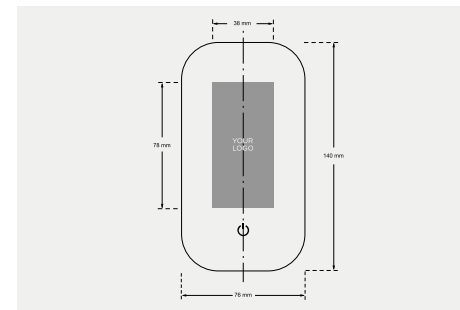

Sérigraphie
Silkscreen



Impression numérique
Digital printing



Produit :	7.7 x 2.4 x 14.2 cm	P. Net :	190 gr
Pack :	11.3 x 4 x 17.7 cm	P. Brut :	260 gr
Carton :	44.5 x 25 x 20 cm	P. Total :	6.2 kg 20 pcs

Product :	3.03 x 0.94 x 5.59"	N.W.:	0.42 lbs
Pack :	4.45 x 1.57 x 6.97"	G.W.:	0.57 lbs
Carton :	17.52 x 9.72 x 8.03"	T.W.:	13.66 lbs 20 pcs

OSLO ENERGY+

Wireless charging station with Bluetooth® speaker & microphones
 Station de charge à induction avec enceinte Bluetooth® & microphones

OSLO ENERGY+

Design by Manuela Simonelli & Andrea Quaglio



<p>CHARGEUR A INDUCTION 10W</p> <p>10W WIRELESS CHARGER</p>	<p>ENCEINTE BLUETOOTH®</p> <p>BLUETOOTH® SPEAKER</p>	<p>DOUBLE MICROPHONE</p> <p>DUAL MICROPHONE</p>	<p>OPTIMISÉ POUR LES CONFÉRENCES AUDIOS</p> <p>OPTIMIZED FOR CONFERENCE CALLS</p>	<p>RÉDUCTION DU BRUIT AMBIANT</p> <p>AMBIANT NOISE CANCELLING</p>	<p>FINITION RÉSISTANTE CUIR SYNTHÉTIQUE</p> <p>DURABLE SYNTHETIC LEATHER FINISH</p>
--	---	--	--	--	--

Station de recharge sans fil avec haut-parleur Bluetooth® et microphones - Station de charge à induction 10W certifiée Qi - Enceinte Bluetooth® 5W - Compatible avec les appareils utilisant la technologie Qi - Appels mains-libres - Double microphones avec réduction du bruit ambiant - Indicateur de charge sans fil et LED Bluetooth® - Version Bluetooth® : 5.0 | Distance Bluetooth® : 10m - Rechargeable par USB-C (câble inclus) et sur adaptateur secteur certifié - Quick Charge 3.0 ou un adaptateur secteur USB DC 9V/2A (non inclus) - Matériaux : Cuir PU - ABS.

Wireless charging station with Bluetooth® speaker & microphones - 10W Qi wireless charging station - 5W Bluetooth® speaker - Compatible with Qi-enabled devices - Hands-free conference calls - Environment noise-cancelling microphones - Wireless charging & Bluetooth® - LED lights indicator - Bluetooth® version: 5.0 | Bluetooth® distance: 10m - Rechargeable via USB-C (cable included) - Power supply: recommend to use with Quick Charge 3.0 power adapter (not included) or a DC 9V/2 power adapter (not included) - Material: PU leather - ABS.

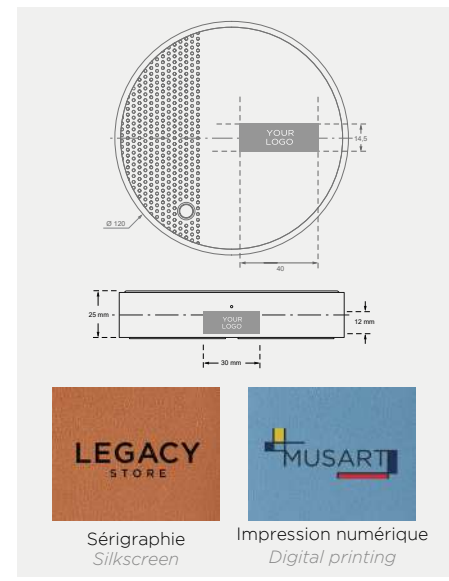
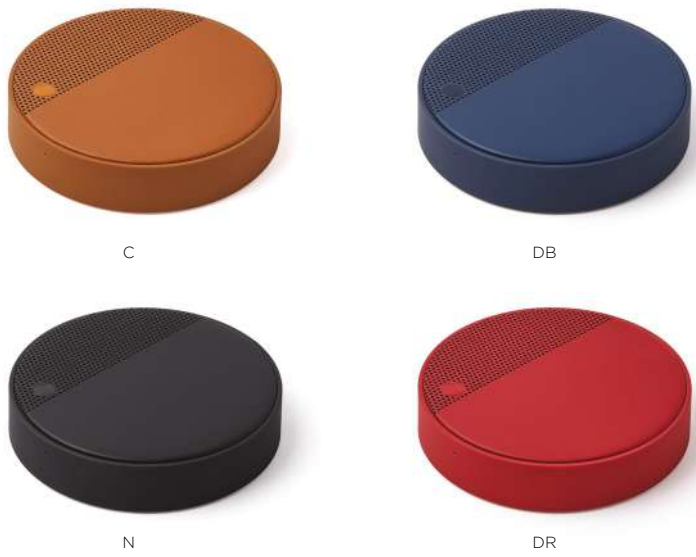

Produit :	Ø12 x 2,5 cm	P. Net :	292 gr
Pack :	15 x 4 x 15 cm	P. Brut :	423 gr
Carton :	32,5 x 21,7 x 32,6 cm	P. Total :	9,04 kg 20 pcs

Product:	Ø4.72 x 0.98"	N.W:	0.64 lbs
Pack:	5.9 x 1.57 x 5.9"	G.W:	0.96 lbs
Carton:	12.8 x 21.54 x 12.8"	T.W:	19.9 lbs 20 pcs

LL130

FINE TUBE POWER BANK 2

3 000 mAh power bank / Batterie externe 3 000 mAh
Design by Pauline Deltour



- BATTERIE EXTERNE
3000 mAh**



3000 mAh
POWER BANK
- PORT
USB**



USB
PORT
- PORT
USB-C**



USB-C
PORT
- FINITION
ALUMINIUM**



ALUMINIUM
FINISH

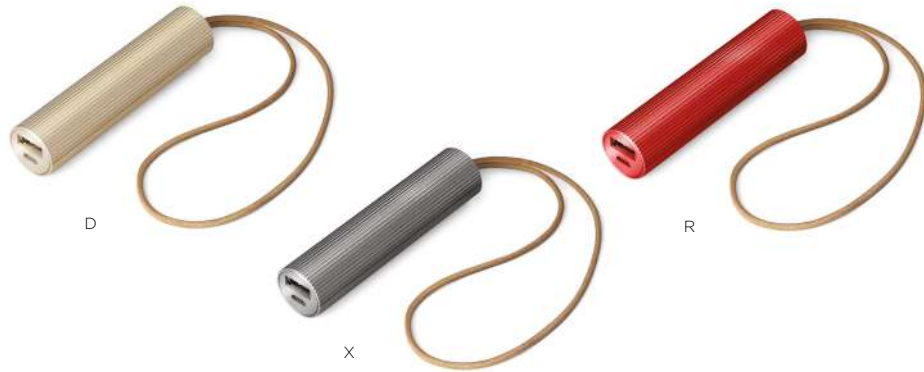

Batterie externe de 3 000 mAh - Port d'entrée USB-C / Port de sortie USB - Matériaux : Aluminium - Cui - Marquage conseillé : laser - tampographie.

3 000 mAh Power Bank - USB-C input port / USB output port - Material: Aluminum - Leather - Suggested branding: laser - pad print.

Produit :	Ø2 x 9.5 cm	P. Net :	45 gr	Product:	Ø0.79 x 3.74"	N.W:	0.1 lbs
Pack :	10 x 2.8 x 4.7 cm	P. Brut :	100 gr	Pack:	3.93 x 0.78 x 1.5"	G.W:	0.22 lbs
Carton :	30.3 x 11.3 x 31.3 cm	P. Total :	6.8 kg	Carton:	12 x 4.45 x 12.32"	T.W:	13.4 lbs

60 pcs

LL138

Best seller

NOMADAY POWER BANK

3000 mAh power bank with clip / Batterie externe 3 000 mAh avec mousqueton
Design by Guillaume Delvigne



- BATTERIE EXTERNE
3000 mAh**



3000 mAh
POWER BANK
- PORT
USB**



USB
PORT
- PORT
USB-C**



USB-C
PORT
- FINITION
ALUMINIUM**



ALUMINIUM
FINISH



Batterie externe de 3 000 mAh - Indicateur LED - Mousqueton intégré 2 ports : USB-A et USB-C - Matériaux : Mousqueton en alliage de zinc - Corps en aluminium - Marquage conseillé : sérigraphie-laser.

3 000 mAh Power Bank - LED indicator - Built-in hook handle 2 ports: USB-A and USB-C - Material: Zinc hook - Aluminum body - Suggested branding: silkscreen-laser.

Produit :	Ø3.5 x 13.3 cm	P. Net :	96 gr	Product:	Ø1.38 x 5.24"	N.W:	0.21 lbs
Pack :	6.8 x 3.1 x 17 cm	P. Brut :	156 gr	Pack:	2.67 x 1.22 x 6.6"	G.W:	0.34 lbs
Carton :	38 x 19 x 43 cm	P. Total :	9.25kg	Carton:	14.96 x 7.48 x 16.85"	T.W:	20.39 lbs

50 pcs

OFFICE
BUREAU



**PEAS
HUB-C**



**CITY
ENERGY PRO**



MUSO



**C-PEN
STYLUS**



C-PEN



BEE 2



SCRIBALU



**CITY
COLLECTION**



**NOMADAY
CARD**



PEAS HUB-C

Hub with USB-C connector for 2 USB-A ports + 2 USB-C ports
Hub avec connectique USB-C pour 2 ports USB-A + 2 ports USB-C



PEAS HUB-C

Design by Valentina & Simone Spalvieri



Hub avec une connectique USB-C pour 2 ports USB-A + 2 ports USB-C - Câble intérieur cuivre -
Matériaux : Gomme siliconée.

Hub with USB-C connector for 2 USB-A ports + 2 USB-C ports - Copper inside cable - Material: Silicone rubber.

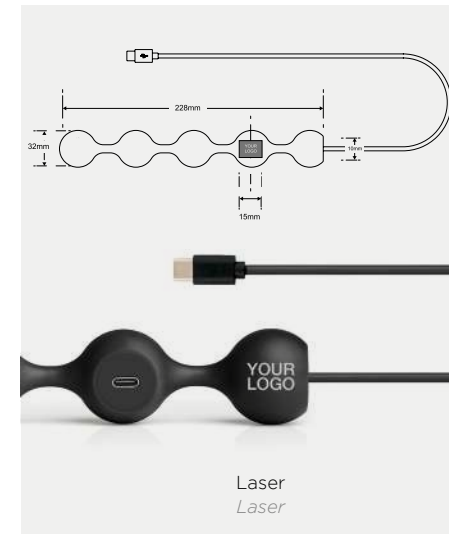

Produit : Ø3.2 x 22.8 cm
Pack : 24 x 5.5 x 4 cm
Carton : 33.9 x 29.5 x 27.4 cm

P. Net : 145 gr
P. Brut : 185 gr
P. Total : 6.1 kg

40 pcs

Product: Ø1.26 x 8.98"
Pack: 9.44 x 2.16 x 1.57"
Carton: 13.34 x 11.61 x 10.79"

N.W: 0.32 lbs
G.W: 0.41 lbs
T.W: 13.45 lbs

40 pcs

CITY ENERGY PRO

Wireless charging station with Bluetooth® speaker & microphones
Station de charge à induction avec enceinte Bluetooth® & microphones



CHARGEUR SANS FIL
RAPIDE 10W



10W WIRELESS
FAST CHARGER

ENCEINTE
BLUETOOTH®



BLUETOOTH®
SPEAKER

DOUBLE
MICROPHONE



DUAL
MICROPHONE

OPTIMISÉ POUR LES
CONFÉRENCES AUDIOS



OPTIMIZED FOR
CONFERENCE CALLS

RÉDUCTION DU
BRUIT AMBIANT



AMBIANT NOISE
CANCELLING

FINITION ALUMINIUM
& CUIR SYNTHÉTIQUE



ALUMINUM & SYNTHETIC
LEATHER FINISH

CITY ENERGY PRO

Design by Manuela Simonelli & Andrea Quaglio



Station de recharge sans fil avec haut-parleur et Microphones Bluetooth® - Station de charge sans fil Qi 10W - Enceinte Bluetooth® - Compatible avec tous les smartphones compatibles à la recharge sans fil Qi - Audioconférences mains-libres - 2 microphones avec technologie de réduction du bruit ambiant - Se recharge sans fil - Voyants lumineux LED Bluetooth® - Version Bluetooth® : 5.0 | Distance Bluetooth® : 10m - Connexion : USB-C (câble inclus) - Matériaux : Cuir synthétique - ABS - Aluminium.

Wireless charging station with Bluetooth® speaker & Microphones - 10W Qi wireless charging station - Bluetooth® speaker - Compatible with all Qi-enabled smartphones - Hands-free conference calls - Environment noise-cancelling microphones - Wireless charging & Bluetooth® LED lights indicator - Bluetooth® version: 5.0 | Bluetooth® distance: 10m - Connection: USB-C (cable included) - Material: Synthetic leather - ABS - Aluminum.



DB

BZ

N

D9

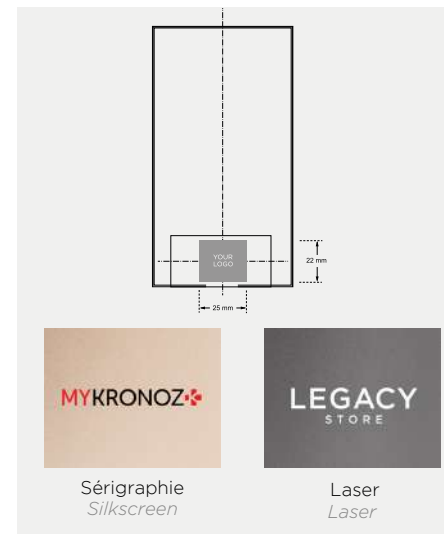

Sérigraphie
Silkscreen

Laser
Laser



Produit : 7.9 x 3.7 x 14.3 cm
Pack : 9.8 x 9 x 17.8 cm
Carton : 49 x 42.6 x 20.5 cm

P. Net : 303 gr
P. Brut : 400 gr
P. Total : 8.5 kg 20 pcs

Product: 3.11 x 1.45 x 5.62"
Pack: 3.85 x 3.54 x 7"
Carton: 19.3 x 16.8 x 8.1"

N.W: 0.21 lbs
G.W: 0.31 lbs
T.W: 18.7 lbs 20 pcs



Souris Bluetooth® sans fil et compacte avec pointeur laser - Deux boutons et une molette de défilement - Haute précision sur de multiples surfaces - Ambidextre - Ergonomie et design parfait - Batterie rechargeable - Autonomie : Jusqu'à 6 mois - Temps de charge : 3h - Rechargeable par USB-C (câble inclus) - Matériaux : Cuir synthétique - ABS - Aluminium.

Wireless and compact Bluetooth® mouse with laser pointer - Dual buttons and precise scroll wheel - High precision on multiple surfaces - Ambidextrous - Perfect ergonomic design - Rechargeable battery - Battery life: Up to 6 months - Charging time: 3h - Rechargeable via USB-C (cable included) - Material: Synthetic leather - ABS - Aluminum.

- DESIGN ERGONOMIQUE**



ERGONOMIC DESIGN
- CLIC SILENCIEUX**



SILENT CLICK
- COMPATIBLE AVEC PLUSIEURS SYSTEMES D'EXPLOITATION**



COMPATIBLE WITH MULTIPLE OS
- JUSQU'À 6 MOIS D'AUTONOMIE**



UP TO 6 MONTHS BATTERY LIFE
- PORT DE CHARGE USB-C**



USB-C CHARGING PORT
- RECHARGEABLE PAR INDUCTION**



WIRELESSLY RECHARGEABLE
- FINITION ALUMINIUM**



ALUMINUM FINISH

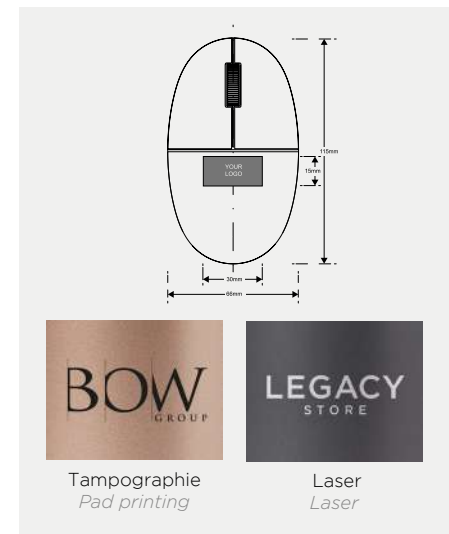

Produit :	11.5 x 6.6 x 3.1 cm	P. Net :	85 gr	N.W. :	0.19 lbs
Pack :	6.9 x 11.9 x 4.8 cm	P. Brut :	125 gr	G.W. :	0.27 lbs
Carton :	30 x 26.6 x 26.8 cm	P. Total :	6 kg	T.W. :	13.22 lbs

40 pcs

C-PEN

Ballpoint pen with 32Bb USB-C drive / *Stylo bille avec clé USB-C 32Go*
Design by Alain Berteau

AWARD



reddit winner 2021



STYLO À BILLE
À ENCRE NOIRE
RECHARGE UNIVERSELLE



BLACK INK
BALLPOINT PEN
UNIVERSAL REFILL

CONNECTEUR
USB-C



USB-C
DRIVE

CAPACITÉ
DE 32GO



32GB
CAPACITY

COMPATIBLE AVEC
LES ORDINATEURS, TABLETTES
ET SMARTPHONES USB-C



COMPATIBLE WITH USB-C
COMPUTERS, TABLETS
AND SMARTPHONES



N



WG



DR



DB



PF



YF

Stylo bille avec clé USB-C 32Go - Recharge universelle Connecteur USB-C - Capacité de 32Go - Stockez jusqu'à 4 000 photos, 7000 chansons ou 40h de vidéos - Compatible : Windows 7, 8 & 10 / Mac OS X v10.6 et supérieur - Matériaux : Acier inoxydable pour clip - Corps principal en ABS.

Ballpoint pen with 32GB USB-C drive - Universal refill - USB-C connector - Capacity of 32GB - Save up to 4,000 pictures, 7,000 songs or 40h of video - Compatible: Windows 7, 8 & 10 / Mac OS X v10.6 and higher - Material: Stainless steel for clip - ABS main body.

Produit :	Ø1.1 x 15 cm	P. Net :	25 gr	Product:	Ø0.43 x 5.90"	N.W.:	0.04 lbs
Pack :	6.6 x 3 x 19.5 cm	P. Brut :	71.8 gr	Pack:	2.59 x 1.18 x 7.67"	G.W.:	0.16 lbs
Carton :	40.5 x 36 x 19 cm	P. Total :	4.35 kg	Carton:	15.94 x 14.17 x 7.47"	T.W.:	9.59 lbs

C-PEN STYLUS

Stylus with 32Bb USB-C drive / *Stylet avec clé USB-C 32Go*
Design by Alain Berteau



STYLET POUR APPAREILS
AVEC ÉCRAN TACTILE



STYLUS FOR TOUCHSCREEN
DEVICES

CONNECTEUR
USB-C



USB-C
DRIVE

CAPACITÉ
DE 32GO



32GB
CAPACITY

COMPATIBLE AVEC
LES ORDINATEURS, TABLETTES
ET SMARTPHONES USB-C



COMPATIBLE WITH USB-C
COMPUTERS, TABLETS
AND SMARTPHONES



N



WG



DR



DB

Stylet avec mémoire flash USB-C - Recharge universelle - Connecteur USB-C - Capacité de 32 Go - Compatible : Windows 7, 8 & 10 / Mac OS X v10.6 et supérieur - Matériaux : Acier inoxydable pour clip - Corps principal en ABS.

Ballpoint pen with 32GB USB-C drive - Universal refill - USB-C connector - Capacity of 32GB - Save up to 4,000 pictures, 7,000 songs or 40h of video - Compatible: Windows 7, 8 & 10 / Mac OS X v10.6 and higher - Material: Stainless steel for clip - ABS main body.

Produit :	Ø1.1 x 15.6 cm	P. Net :	22 gr	Product:	Ø0.43 x 6.14"	N.W.:	0.06 lbs
Pack :	6.6 x 3 x 19.5 cm	P. Brut :	70 gr	Pack:	2.59 x 1.18 x 7.67"	G.W.:	0.15 lbs
Carton :	40.5 x 36 x 19 cm	P. Total :	4.1 kg	Carton:	15.94 x 12.79 x 8.66"	T.W.:	9.04 lbs

BEE 2

Twisting ballpoint pen & stylus / *Stylo à bille rotatif & stylet*
Design by Lexon Studio



SCRIBALU

Rollerball pen on base / *Stylo roller sur socle*
Design by Lexon Studio



Stylo à bille rotatif 2-en-1 / *Stylet* - Recharge universelle - Matériaux : Laiton - Marquage conseillé : sérigraphie - laser.

2-in-1 twist ballpoint pen / *stylus* - Universal refill - Material: Brass - Suggested branding: silkscreen - laser.

Produit :	Ø0.8 x 14.2 cm	P. Net :	18 gr	Product:	Ø0.3 x 5.6"	N.W.:	0.04 lbs
Pack :	18.3 x 2 x 5 cm	P. Brut :	65 gr	Pack:	7.2 x 0.78 x 1.9"	G.W.:	0.14 lbs
Carton :	41.5 x 29 x 24 cm	P. Total :	6 kg	Carton:	16.14 x 11.42 x 9.45"	T.W.:	13.22 lbs

100 pcs

Colors on request / *Couleurs sur demande*

Stylo roller sur socle - Recharge universelle - Matériaux : Aluminium - Marquage conseillé: sérigraphie - laser.

Rollerball pen on a base - Universal refill - Material: Aluminum - Suggested branding: laser - silkscreen.

Produit :	Ø4 x 18 cm	P. Net :	150 gr	Product:	Ø1.6 x 7"	N.W.:	0.33 lbs
Pack :	4.8 x 4.8 x 18 cm	P. Brut :	170 gr	Pack:	1.89 x 1.89 x 7.08"	G.W.:	0.37 lbs
Carton :	39 x 24 x 24 cm	P. Total :	9 kg	Carton:	15.35 x 9.45 x 9.4"	T.W.:	19.84 lbs

50 pcs

NOMADAY CARD

Case for 15 business cards / Étui pour 15 cartes de visite

Design by Guillaume Delvigne



DG1



DR



N



DB



D



X

Étui pour 15 cartes de visite - Matériaux : Aluminium - ABS - Marquage conseillé : sérigraphie - laser.

Business card case for 15 cards - Material: Aluminum - ABS - Suggested branding: Silkscreen - Laser.

Produit :	6.4 x 1 x 11.4 cm	P. Net :	50 gr	Product:	2.51 x 0.4 x 4.48"	N.W.:	0.11 lbs
Pack :	8.1 x 1.7 x 13.2 cm	P. Brut :	75 gr	Pack:	3.2 x 0.7 x 5.2"	G.W.:	0.16 lbs
Carton :	57 x 23 x 18 cm	P. Total :	5.4 kg	Carton:	22.44 x 8.66 x 7.09"	T.W.:	11.9 lbs
			60 pcs				60 pcs



CITY COLLECTION

Design by Manuela Simonelli & Andrea Quaglio

CITY COLLECTION

Design by Manuela Simonelli & Andrea Quaglio



**LD135
RULER**



Règle de 20 cm - Matériaux : aluminium - Marquage conseillé : sérigraphie - laser.

20 cm ruler - Material: Aluminum - Suggested branding: silkscreen - laser.

23,5 x 3,2 x 0,9 cm / P. Brut : 63 g
Colisage : 100p / 7,5 kg
9,2 x 1,2 x 0,3" I.G.W: 0,14 lbs
Carton: 100p / 16,5 lbs



**LD139
TAPE DISPENSER**



Dévidoir de ruban adhésif - Rouleau adhésif mat fourni - Matériaux : aluminium. - Marquage conseillé : sérigraphie - laser.

Desk tape dispenser - Matt tape included - Material: Aluminum - Suggested branding: silkscreen - laser.

9,7 x 4 x 5,5 cm / P. Brut : 181 g
Colisage : 40p / 8 kg
3,8 x 1,6 x 2,1" I.G.W: 0,4 lbs
Carton : 40p / 17,7 lbs



**LD138
DESK TRAY**



Vide poche - 4 compartiments - Matériaux : aluminium - Marquage conseillé : sérigraphie - laser - impression numérique.

Round desk tray - 4 compartments - Material: Aluminum - Suggested branding: silkscreen - laser - digital printing.

Ø 10,2 x 2,9 cm / P. Brut : 140 g
Colisage : 40p / 7,5 kg
Ø 4 x 1,1" I.G.W: 0,31 lbs
Carton: 40p / 16,5 lbs



**LD137
CARD STAND**



Support pour cartes de visite - Matériaux : aluminium - Marquage conseillé : sérigraphie - laser.

Business card holder - Material: Aluminum - Suggested branding: silkscreen - laser.

10,3 x 7,9 x 5,4 cm / P. Brut : 84 g
Colisage : 40p / 5 kg
4 x 3,1 x 2,1" I.G.W: 0,2 lbs
Carton: 40p / 10,8 lbs



**LD140
PEN CUP**

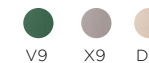

Pot à crayons - Matériaux : aluminium - Marquage conseillé : sérigraphie - laser.

Pen cup - Material: Aluminum - Suggested branding: silkscreen - laser.

Ø 7 x 8,8 cm / P. Brut : 153 g
Colisage : 40p / 7,6 kg
Ø 2,7 x 3,4" I.G.W: 0,34 lbs
Carton: 40p / 17 lbs



**LD14
CARD BOX**

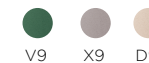

Étui pour 20 cartes de visite - Matériaux : aluminium anodisé - Marquage conseillé : sérigraphie sur laser - embossage en fabrication spéciale.

Business card case for 20 cards - Material: Anodised aluminum - Suggested branding: silkscreen - laser - special production embossing.

9,3 x 6,1 x 0,9 cm / P. Brut : 38 g / 3 kg
Colisage : 300 p / 12,840 kg
3,7 x 2,4 x 0,3" I.G.W: 0,1 lbs
Carton: 300p / 28 lbs

ACCESSORIES
ACCESSOIRES



WINO



**NOMADAY
LOCK**

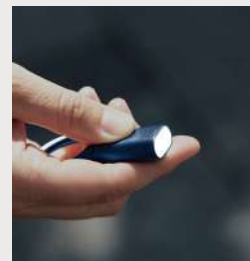

**NOMADAY
LIGHT**

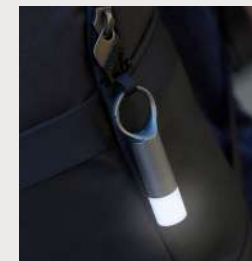

**NOMADAY
FLASH**

LUCIE



**FINE BAG
LIGHT 2**



**MINI HOOK
UMBRELLA**

WINO

Mini portable fan / Mini ventilateur portable



3 VITESSES
AJUSTABLES



3 ADJUSTABLE
SPEEDS

PALES ULTRA
SILENCIEUSES



ULTRA-QUIET
BLADES

JUSQU'À 5H
D'AUTONOMIE



UP TO 5H
BATTERY LIFE

RECHARGEABLE
PAR INDUCTION



WIRELESSLY
RECHARGEABLE

RECHARGEABLE
PAR USB-C



RECHARGEABLE
VIA USB-C

BASE EN
ALUMINIUM



ALUMINIUM
BASE



New colors / Nouvelles couleurs

WINO

Design by Manuela Simonelli & Andrea Quaglio



Mini ventilateur portable avec recharge par induction - 3 vitesses de ventilation - Pales ultra silencieuses - Jusqu'à 5h d'autonomie - Temps de charge : 2h - Rechargeable par induction - Port USB-C - Matériaux : base en aluminium & tête en ABS.

Mini hand-held fan with wireless charge - 3 Airflow speeds - Ultra-quiet blades - Up to 5h battery life - Charging time: 2h - Wirelessly rechargeable - USB-C port - Material: Aluminum base & ABS head.

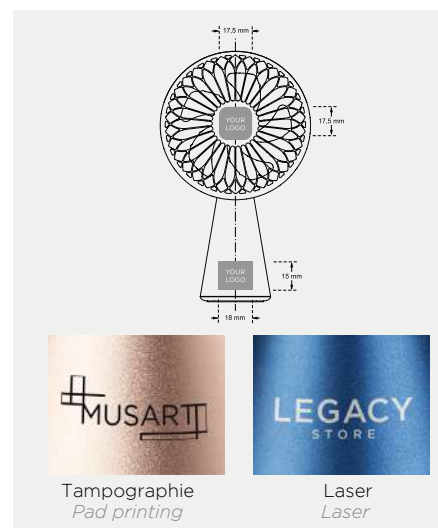

Produit : 7.9 x 4.8 x 13.1 cm
 Pack : 8.3 x 5 x 13.6 cm
 Carton : 35 x 28 x 30 cm
 P. Net : 84 gr
 P. Brut : 158 gr
 P. Total : 7.2 kg 40 pcs



Product: 3.11 x 1.89 x 5.15"
 Pack: 3.27 x 1.97 x 13.6"
 Carton: 13.78 x 11.03 x 8.88"
 N.W: 0.18 lbs
 G.W: 0.35 lbs
 T.W: 15.87 lbs 40 pcs

NOMADAY LOCK

Biometric fingerprints padlock
Cadenas biométrique à empreintes digitales



- OUVERTURE EN MOINS DE 0.5 SEC**
UNLOCKING IN LESS THAN 0.5 SEC
- ENREGISTRE JUSQU'À 10 EMPREINTES DIFFÉRENTES**
STORE UP TO 10 DIFFERENT FINGERPRINTS
- RÉSISTANT À LA PLUIE IP65**
IP65 RAIN-PROOF
- JUSQU'À 12 MOIS D'AUTONOMIE**
UP TO 12 MONTHS BATTERY LIFE
- RECHARGEABLE PAR USB-C**
RECHARGEABLE VIA USB-C



NOMADAY LOCK

Design by Guillaume Delvigne



Cadenas biométrique à empreintes digitales - Usage intérieur/extérieur - Ouverture en moins de 0.5 seconde - Enregistre jusqu'à 10 empreintes différentes - Indicateur LED - Autonomie : jusqu'à 3000 déverrouillages après une charge complète / Autonomie en veille : jusqu'à 12 mois - Temps de charge : 1h30 - Rechargeable par USB-C (câble inclus) - Résistance à l'eau : IP65 - Matériaux : Bague en acier inoxydable et corps en alliage de zinc.

Biometric fingerprints padlock - Indoor/Outdoor use - Unlocking in less than 0.5 second - Stores up to 10 different fingerprints - LED indicator - Battery life: up to 3000 unlock times after full charge / Stand by time: up to 12 months - Charging time: 1.5h - Rechargeable via USB-C (cable included) - Water resistance: IP65 - Material: Stainless steel ring and Zinc alloy body.

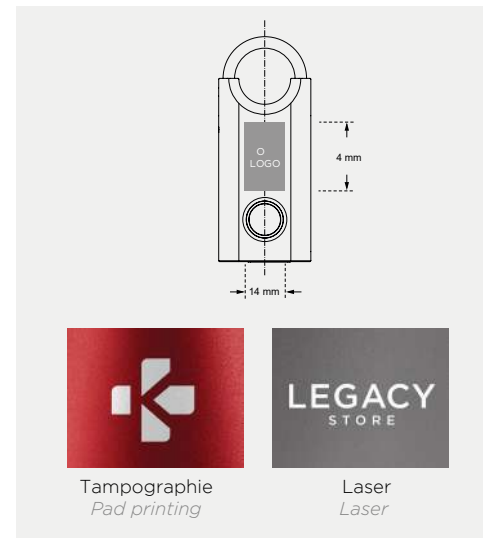

Produit :	3.2 x 1.4 x 7.6 cm	P. Net :	84 gr	Product:	1.25 x 0.55 x 2.99"	N.W:	0.18 lbs
Pack :	7 x 3 x 11.5 cm	P. Brut :	140 gr	Pack:	2.75 x 1.18 x 4.5"	G.W:	0.31 lbs
Carton :	29 x 31 x 18 cm	P. Total :	6.38 kg	Carton:	11.34 x 12.2 x 7.09"	T.W:	14.1 lbs
			40 pcs				40 pcs

LL136

NOMADAY LIGHT

Mini LED torch keyring with clip / Porte-clés mousqueton avec mini torche LED
Design by Guillaume Delvigne



- LUMIÈRE LED BLANCHE**
 WHITE LED LIGHT
- VISIBLE JUSQU'À 50 M**
 VISIBLE UP TO 50 M
- MOUSQUETON INTÉGRÉ**
 BUILT-IN CLIP
- JUSQU'À 1H D'AUTONOMIE**
 UP TO 1H BATTERY LIFE
- RECHARGEABLE PAR USB-C**
 RECHARGEABLE VIA USB-C
- FINITION ALUMINIUM**
 ALUMINIUM FINISH



Porte-clés mousqueton avec mini torche LED - Lumière visible jusqu'à 50 mètres - Temps de charge : 1h - Rechargeable par USB-C (câble inclus) - Matériaux : ABS - Alliage de zinc - Acier inoxydable - Marquage conseillé : laser - sérigraphie.

Mini LED torch keyring with hook - Visible light up to 150 feet - Charging time: 1h - Rechargeable via USB-C (cable included) - Material: ABS - Zinc Alloy - Stainless steel - Suggested branding: laser - pad print.

Produit :	3.2 x 1 x 6 cm	P. Net :	24 gr	Product:	1.25 x 0.39 x 2.36"	N.W:	0.05 lbs
Pack :	6.3 x 3.1 x 9.7 cm	P. Brut :	62 gr	Pack:	2.48 x 1.22 x 3.82"	G.W:	0.14 lbs
Carton :	36.2 x 29.1 x 28.8 cm	P. Total :	6.3 kg	Carton:	14.26 x 11.46 x 11.34"	T.W:	13.99 lbs

80 pcs

LL137

NOMADAY FLASH

Wearable LED lamp with clip / Lampe LED de signalisation avec mousqueton
Design by Guillaume Delvigne



- LED ROUGE OU BLANCHE 4 MODES D'ÉCLAIRAGE**
 RED OR WHITE LED WITH 4 LIGHTING MODES
- VISIBLE JUSQU'À 200 M**
 VISIBLE UP TO 200M
- MOUSQUETON INTÉGRÉ**
 BUILT-IN CLIP
- JUSQU'À 12H D'AUTONOMIE**
 UP TO 12H BATTERY LIFE
- RECHARGEABLE PAR USB-C**
 RECHARGEABLE VIA USB-C
- FINITION ALUMINIUM**
 ALUMINIUM FINISH
- IPX4 HAUTE RÉSISTANCE À LA PLUIE**
 HIGH RESISTANCE RAIN-PROOF IPX4



Lampe LED de signalisation avec mousqueton - Lumière rouge ou blanche Fixe ou clignotante - Résistance à la pluie IPX4 - Lumière visible jusqu'à 200 mètres - Autonomie : 12h - Temps de charge : 1h30 - Rechargeable par USB-C (câble inclus) - Matériaux : ABS - Alliage de zinc - Acier inoxydable - Marquage conseillé : laser - sérigraphie.

Wearable LED lamp with clip - Red or white light - Fixed or blinking - IPX4 Rain resistant - Visible light up to 600 feet - Battery life: 12h - Charging time: 1.5h - Rechargeable via USB-C (cable included) - Material: ABS - Zinc Alloy - Stainless steel. - Suggested branding: laser - pad print.

Produit :	3.2 x 1.8 x 10 cm	P. Net :	61 gr	Product:	1.25 x 0.70 x 3.9"	N.W:	0.14 lbs
Pack :	6.8 x 3.1 x 14 cm	P. Brut :	115 gr	Pack:	2.67 x 1.22 x 5.51"	G.W:	0.25 lbs
Carton :	39 x 31 x 19 cm	P. Total :	5.7 kg	Carton:	15.35 x 12.3 x 7.6"	T.W:	12.57 lbs

40 pcs

LL121

LUCIE

Wearable LED clip / *Clip LED de signalisation*
Design by Yoann Jacquon



LL129

FINE BAG LIGHT 2

LED bag light / *Lampe LED pour sac à main*
Design by Pauline Deltour



LAMPE LED



LED LIGHT

VISIBLE JUSQU'À 150 M



VISIBLE UP TO 150M

CLIP COMPACT ET ULTRA STABLE



COMPACT & SECURE CLIP

RÉSISTANCE À LA PLUIE



RAIN RESISTANT

RECHARGEABLE PAR USB-C



RECHARGEABLE VIA USB-C

LAMPE LED



LED LIGHT

RECHARGEABLE PAR USB-C



RECHARGEABLE VIA USB-C

FINITION ALUMINIUM



ALUMINIUM FINISH



B

D

X

R

N

Clip LED de signalisation - Lumière blanche ou rouge - Fixe ou clignotante - Rechargeable - Résistance à la pluie IPX4 - Lumière visible jusqu'à 150 mètres - Autonomie : jusqu'à 12h - Temps de charge : 2h - Rechargeable par USB-C (câble inclus) - Matériaux : Aluminium - ABS - Marquage conseillé : sérigraphie.

Wearable LED clip - Red or white light - Fixed or blinking Rechargeable Rain resistance IPX4 - Visible light up to 500 feet Battery life: up to 12h - Charging time: 2h - Rechargeable via USB-C (cable included) - Material: Aluminum- ABS - Suggested branding: silkscreen.

Produit :	3.1 x 1.3 x 4.8 cm	P. Net :	18 gr	Product:	1.2 x 0.5 x 1.8"	N.W:	0.04 lbs
Pack :	6.4 x 3.1 x 8 cm	P. Brut :	57 gr	Pack:	2.36 x 1.18 x 3.14"	G.W:	0.12 lbs
Carton :	36 x 29 x 22 cm	P. Total :	5.6 kg	Carton:	14.17 x 11.42 x 8.66"	T.W:	12.34 lbs
			80 pcs				80 pcs



D

X

R

Lampe pour sac à main - LED ultra lumineuse - Autonomie : jusqu'à 4 heures après une charge complète - Autonomie en veille : jusqu'à 6 mois - Temps de charge : 1,5h - Rechargeable par USB-C (câble inclus) - Matériaux : Aluminium - ABS - Cuir - Marquage conseillé : laser - tampographie.

Bag light - Super bright LED - Battery life: up to 4 hours after a full charge - Standby time: up to 6 months - Charging time: 1,5h - Rechargeable via USB-C (cable included) - Material: Aluminum - ABS - Leather - Suggested branding: laser - pad print.

Produit :	Ø2.2 x 9.6 cm	P. Net :	70 gr	Product:	Ø0.87 x 3.78"	N.W:	0.15 lbs
Pack :	15 x 3 x 6.8 cm	P. Brut :	107 gr	Pack:	2.67 x 1.22 x 5.51"	G.W:	0.23 lbs
Carton :	38 x 36 x 20 cm	P. Total :	5.6 kg	Carton:	5 x 14.21 x 7.96"	T.W:	12.3 lbs
			50 pcs				50 pcs



MINI HOOK UMBRELLA

Design by Theo Williams



M1 LP LL



R O1 J8 B LB1 K9 N6 G3

Parapluie pliable 2 sections - Poignée mousqueton - Matériaux : Axe aluminium - Toile en rPET - Poignée ABS gomme - Marquage conseillé : sérigraphie.

Foldable umbrella 2 sections - hook handle - Material: Aluminum shaft - rPET fabric - ABS rubber handle - Suggested branding: silkscreen.

Produit :	Fermé: Ø5 x 51 cm Ouvert: Ø122 x 50 cm	P. Net :	405 gr	Product:	Closed: Ø1.97 x 20.07" Open: Ø48.03 x 20.07"	N.W.:	0.9 lbs
Pack :	Ø5.2 x 51.5 cm	P. Brut :	410 gr	Pack :	Ø1.97 x 20.07"	G.W.:	0.94 lbs
Carton :	53 x 29 x 23.5 cm	P. Total :	11 kg	Carton :	20.87 x 11.42 x 9.25"	T.W.:	24.25 lbs 24 pcs

New colors / Nouvelles couleurs









BAGS SACS

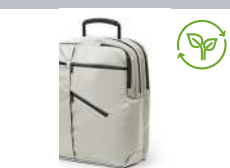

YOU CARRY, WE CARE

At Lexon, we are committed to offer durable solutions by sourcing innovative and responsible materials. 2024 marks the beginning of our move towards sustainability as we will progressively shift our entire bag category to be made in environmentally-friendly fabrics such as rPET.

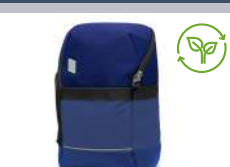
Chez Lexon, nous nous engageons à offrir des solutions durables en sélectionnant des matériaux innovants et responsables. 2024 marque le début de notre évolution vers la durabilité ; la transformation de l'ensemble de notre catégorie bagagerie est en marche, avec pour objectif de fabriquer toutes nos collections dans des tissus respectueux de l'environnement tels que le rPET.

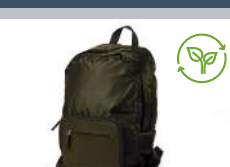
	ONE+
PREMIUM+	
	TRACK
CHALLENGER	
	EVE
TERA	
	PEANUT
PACKABLE	



**LC2806
TECH POUCH**



Pochette à bandoulière pour smartphone avec 2 compartiments.
Sling pouch for smartphone with 2 compartments

Produit : 11 x 2.5 x 20 cm
P. Net : 120 gr
Carton : Info bientôt disponible

Product: 4.33 x 0.98 x 7.87"
N.W: 0.26 lbs
Carton: Info coming soon

**LC2807
TECH ORGANIZER**



Pochette pour accessoires électroniques - Ouverture à plat
Pouch for electronic accessories - Flat opening

Produit : 19 x 8.5 x 11 cm
P. Net : 100 gr
Carton : Info bientôt disponible

Product: 7.48 x 3.35 x 4.33"
N.W: 0.22 lbs
Carton: Info coming soon

**LC2808
MINI POUCH**



Pochette dotée d'une dragonne
Pouch with wrist strap

Produit : 21 x 5 x 12 cm
P. Net : 80 gr
Carton : Info bientôt disponible

Product: 8.27 x 1.97 x 4.72"
N.W: 0.18 lbs
Carton: Info coming soon

LC2801 2 IN 1 DOCUMENT BAG



14"



Porte-documents convertible en sac à dos - Compartiment pour ordinateur 14" - Poignées rétractables - Sangles dissimulables - Fermetures gomme étanche - Capacité : 5 L
Convertible briefcase to backpack - 14" laptop compartment - Retractable handles - Concealable handles - Waterproof rubber zippers - Capacity: 5 L

Produit : 38 x 5.5 x 26.5 cm P. Net : 475 gr
Carton : P. Total : 11.4 kg 24 pcs

Product: 14.96 x 2.16 x 10.42" N.W: 1.05 lbs
Carton: T.W: 25.2 lbs 24 pcs

LC2802 DOCUMENT BAG



15"

16"



Porte-documents et ordinateur - Compartiment pour ordinateur jusqu'à 16" - Bandoulière - Capacité : 17 L
Laptop document bag - Compatible up to 16" laptop - Shoulder strap - Capacity: 17 L

Produit : 41.5 x 9 x 31 cm P. Net : 420 gr
Carton : P. Total : 10.1 kg 24 pcs

Product: 16.34 x 3.54 x 12.20" N.W: 0.93 lbs
Carton: T.W: 22.27 lbs 24 pcs

LC2800 BACKPACK / LC2803 DOUBLE BACKPACK



15"

16"

Sac à dos - Compartiment pour ordinateur jusqu'à 16" - Capacité: 14 L
Backpack - Compatible up to 16" laptop - Capacity: 14 L

Produit : 28 x 13 x 38 cm P. Net : 550 gr
Carton : P. Total : 13.4 kg 24 pcs

Product: 11.02 x 5.12 x 14.96" N.W: 1.21 lbs
Carton: T.W: 29.10 lbs 24 pcs

Sac à dos double - Compartiment pour ordinateur jusqu'à 16" - Capacité: 15 L
Double laptop backpack - Compatible up to 16" laptop - Capacity: 15 L

Produit : 28 x 14 x 38 cm P. Net : 560 gr
Carton : P. Total : 13.4 kg 24 pcs

Product: 11.02 x 5.51 x 14.96" N.W: 1.23 lbs
Carton: T.W: 29.54 lbs 24 pcs

LC2804 SLIM LAPTOP BAG



13"

14"



Porte-documents et ordinateur - Compartiment pour ordinateur jusqu'à 14" - Capacité: 5 L
Laptop document bag - Compatible up to 14" laptop - Capacity: 5 L

Produit : 37 x 5 x 29 cm P. Net : 350 gr
Carton : P. Total : 8.4 kg 24 pcs

Product: 14.56 x 1.96 x 11.42" N.W: 0.77 lbs
Carton: T.W: 18.52 lbs 24 pcs

LC2805 DUFFLE BAG



Sac de voyage - Base renforcée - Capacité: 30 L
Travel bag - reinforced base - Capacity: 30 L

Produit : 45 x 23 x 30 cm P. Net : 550 gr
Carton : P. Total : 6.6 kg 24 pcs

Product: 17.71 x 9.05 x 11.81" N.W: 1.21 lbs
Carton: T.W: 14.55 lbs 24 pcs



LN2700 A4 FOLDER



Conférencier A4 - Bloc-notes 50 feuilles
A4 blinder - 50 pages memo pad

Produit :	33 x 2 x 25 cm	P. Net :	850 gr
Carton :	P. Total : 10.4 kg		12 pcs
Product:	12.99 x 0.78 x 9.84"	N.W.:	1.87 lbs
Carton:	T.W. : 22.92 lbs		12 pcs

LN2702 MEDIUM LAPTOP BAG



Porte-documents et ordinateur - Compartiment pour ordinateur jusqu'à 14" - Bandoulière large - 2 poignées en aluminium - Capacité: 6 L
Laptop document bag - Compatible up to 14" laptop - Wide shoulder strap - 2 aluminium handles - Capacity: 6 L

Produit :	36 x 6.5 x 27.5 cm	P. Net :	570 gr
Carton :	P. Total : 6.8 kg		12 pcs
Product:	14.2 x 2.5 x 10.8"	N.W.:	1.25 lbs
Carton:	T.W. : 14.99 lbs		12 pcs

LN2701 SLIM LAPTOP BAG



Porte-documents et ordinateur - Compartiment pour ordinateur jusqu'à 14" - Capacité: 5 L
Laptop document bag - Compatible up to 14" laptop - Capacity: 5 L

Produit :	37 x 5 x 26 cm	P. Net :	280 gr
Carton :	P. Total : 6.7 kg		24 pcs
Product:	14.57 x 1.97 x 10.24"	N.W.:	0.62 lbs
Carton:	T.W. : 14.77 lbs		24 pcs

LN2703 LARGE LAPTOP BAG



Porte-documents et ordinateur - Compartiment pour ordinateur jusqu'à 16" - Bandoulière large - 2 poignées en aluminium - Capacité: 10 L
Laptop document bag - Compatible up to 16" laptop - Wide shoulder strap - 2 aluminium handles - Capacity: 10 L

Produit :	40 x 9 x 30.5 cm	P. Net :	640 gr
Carton :	P. Total : 9.7 kg		12 pcs
Product:	15.74 x 3.54 x 12.01"	N.W.:	1.41 lbs
Carton:	T.W. : 21.38 lbs		12 pcs

LN2704 SLIM BACKPACK



Sac à dos - Compartiment pour ordinateur jusqu'à 14" - Capacité: 16 L
Backpack - Compatible up to 14" laptop - Capacity: 16 L

Produit :	29 x 14 x 40 cm	P. Net :	480 gr
Carton :	P. Total : 5.7 kg		12 pcs
Product:	11.42 x 5.51 x 15.75"	N.W.:	1.06 lbs
Carton:	T.W. : 12.57 lbs		12 pcs

LN2705 DOUBLE BACKPACK



Sac à dos double - Compartiment pour ordinateur jusqu'à 16" - Capacité: 17 L
Double laptop backpack - Compatible up to 16" laptop - Capacity: 17 L

Produit :	29 x 14.5 x 40 cm	P. Net :	610 gr
Carton :	P. Total : 8 kg		24 pcs
Product:	11.42 x 5.71 x 15.7"	N.W.:	1.34 lbs
Carton:	T.W. : 17.64 lbs		24 pcs

LN2706 DUFFLE BAG



Sac de voyage - Base renforcée - 2 poignées en aluminium - Capacité: 32 L
Travel bag - reinforced base - Capacity: 32 L

Produit :	45 x 23.5 x 30.5 cm	P. Net :	670 gr
Carton :	P. Total : 10.7 kg		12 pcs
Product:	17.72 x 9.25 x 12.01"	N.W.:	1.47 lbs
Carton:	T.W. : 23.59 lbs		12 pcs

LN2707 TOILETRY BAG



Trousse de toilette - Capacité: 3.5 L
Toiletry bag - Capacity: 3.5 L

Produit :	22.5 x 16.5 x 16 cm	P. Net :	320 gr
Carton :	P. Total : 11.5 kg		36 pcs
Product:	8.9 x 6.5 x 6.3"	N.W.:	0.7 lbs
Carton:	T.W. : 25.3 lbs		36 pcs



LN2406 15" DOCUMENT BAG

15"



B N K G

Porte-documents et ordinateur - Compartiment pour ordinateur 15" - Bandoulière - Capacité: 11 L
Laptop document bag - 15" laptop compartment - Shoulder strap - Capacity: 11 L

Produit :	40 x 10 x 29 cm	P. Net :	560 gr
Carton :	P. Total : 11.20 kg		20 pcs
Product :	15.74 x 3.94 x 11.4"	N.W. :	1.23 lbs
Carton :	T.W. : 24.69 lbs		20 pcs

LN2404 DOCUMENT BACKPACK

15"



B
N
K
G

Porte-documents et sac à dos - Compartiment pour ordinateur 15" - Capacité: 12 L
Document bag & Backpack - 15" laptop compartment - Capacity: 12 L

Produit :	29 x 10.5 x 42 cm	P. Net :	860 gr
Carton :	P. Total : 6.9 kg		8 pcs
Product :	11.42 x 4.13 x 16.53"	N.W. :	1.89 lbs
Carton :	T.W. : 15.21 lbs		8 pcs

LN2405 ENVELOP BRIEF

15"



B
N
K
G

Porte-documents et ordinateur - Compartiment pour ordinateur 15" - Capacité: 11 L
Laptop document bag - 15" laptop compartment

Produit :	40 x 4 x 28 cm	P. Net :	420 gr
Carton :	P. Total : 8.4 kg		20 pcs
Product :	15.74 x 1.6 x 11"	N.W. :	0.92 lbs
Carton :	T.W. : 18.51 lbs		20 pcs

LN2400 A4 FOLDER



B
N
K
G

Conférencier A4 - Fermeture à glissière
A4 folder - Zipper closure

Produit :	24 x 2 x 33 cm	P. Net :	470 gr
Carton :	P. Total : 10.70 kg		20 pcs
Product :	9.45 x 0.79 x 12.99"	N.W. :	1.04 lbs
Carton :	T.W. : 23.59 lbs		20 pcs

LN2401 LAPTOP BRIEF

13"

14"



Porte-documents et ordinateur - Compartiment pour ordinateur jusqu'à 14" - Capacité: 11 L
Laptop document bag - Compatible up to 14" laptop

Produit :	40 x 3 x 27 cm	P. Net :	420 gr
Carton :	P. Total : 8.4 kg		20 pcs
Product :	15.74 x 1.18 x 10.63"	N.W. :	0.92 lbs
Carton :	T.W. : 18.52 lbs		20 pcs

LN2402 SIMPLE BACKPACK

13"

14"



B
N
K
G

Sac à dos - Compartiment pour ordinateur jusqu'à 14" - Capacité: 18 L
Backpack - Compatible up to 14" laptop - Capacity: 18 L

Produit :	28 x 16 x 40 cm	P. Net :	590 gr
Carton :	P. Total : 4.7 kg		8 pcs
Product :	11.02 x 6.3 x 15.75"	N.W. :	1.30 lbs
Carton :	T.W. : 10.36 lbs		8 pcs

LN2403 DOUBLE BACKPACK

13"

14"



B
N
K
G

Sac à dos double - Compartiment pour ordinateur jusqu'à 14" - Capacité: 20 L
Double backpack - Compatible up to 14" laptop - Capacity: 20 L

Produit :	28 x 18 x 40 cm	P. Net :	690 gr
Carton :	P. Total : 7.3 kg		8 pcs
Product :	11.02 x 7.09 x 15.75"	N.W. :	1.52 lbs
Carton :	T.W. : 16.09 lbs		8 pcs



CHALLENGER

Design by Marco Pulga & Luca Artioli

CHALLENGER

Design by Marco Pulga & Luca Artioli



LC654 BACKPACK



15"

16"



- N
- B
- BG
- W



Sac à dos double - Compartiments pour ordinateur jusqu'à 16" et tablettes - Dos renforcé - Poignée rétractable - Sangles dissimulables - Fermetures gomme étanche - Capacité : 20 L

Double backpack - Compatible up to 16" laptop & tablet compartments - Reinforced back - Retractable handle - Concealable handles - Waterproof rubber zippers - Capacity: 20 L

Produit :	30 x 17 x 40 cm	P. Net :	890 gr
Carton :	P. Total : 5.3 kg		6 pcs
Product:	11.8 x 6.7 x 15.7"	N.W.:	1.96 lbs
Carton:	T.W: 11.68 lbs		6 pcs

LC662 DOCUMENT BACKPACK



15"

16"



- N
- B
- BG
- W



Porte-documents convertible en sac à dos - Compartiments ordinateur 16" et tablettes - Poignées rétractables - Sangles dissimulables - Fermetures gomme étanche - Capacité : 12 L

Convertible briefcase into backpack - 16" laptop & tablet compartments Retractable handles - Concealable handles - Waterproof rubber zippers - Capacity: 12 L

Produit :	30 x 10 x 41 cm	P. Net :	900 gr
Carton :	P. Total : 10.8 kg		12 pcs
Product:	11.8 x 3.9 x 16.1"	N.W.:	2 lbs
Carton:	T.W: 23.8 lbs		12 pcs

LC663 LAPTOP BRIEF



15"

16"

- N
- B
- BG
- W



Porte-documents extra plat pour ordinateur jusqu'à 16" - Fermetures gomme étanche

Extra-slim document bag - Compatible up to 16" laptop - Waterproof rubber zippers

Produit :	39 x 2 x 28 cm	P. Net :	430 gr
Carton :	P. Total : 8.6 kg		20 pcs
Product:	15.35 x 0.79 x 11.02"	N.W.:	0.94 lbs
Carton:	T.W: 18.96 lbs		20 pcs

LC664 13" LAPTOP BRIEF



13"

- N
- B
- BG
- W



Porte-documents extra plat pour ordinateur 13" - Fermetures gomme étanche

Extra-slim 13" laptop document bag - Waterproof rubber zippers

Produit :	36.5 x 2 x 25 cm	P. Net :	420 gr
Carton :	P. Total : 8.4 kg		20 pcs
Product:	14.37 x 0.79 x 9.84"	N.W.:	0.92 lbs
Carton:	T.W: 18.51 lbs		20 pcs

LC651 DOCUMENT BAG



13"

14"

- N
- B
- BG
- W



Porte documents et ordinateur - Compartiment pour ordinateur jusqu'à 14" - Poignées rétractables - Poches zippées en façade

Laptop document bag - Compatible up to 14" laptop - Retractable handles - Front zip pockets

Produit :	40 x 30.5 x 6.5 cm	P. Net :	590 gr
Carton :	P. Total : 10.6 kg		18 pcs
Product:	15.75 x 12.01 x 2.56"	N.W.:	1.3 lbs
Carton:	T.W: 23.37 lbs		18 pcs

LC652 DOCUMENT BAG



15"

16"

- N
- B
- BG
- W



Porte documents et ordinateur - Compartiment ordinateur jusqu'à 16" - Poignées rétractables - Poches zippées en façade

Laptop document bag - Compatible up to 16" laptop - Retractable handles - Front zip pockets

Produit :	40 x 30 x 9 cm	P. Net :	820 gr
Carton :	P. Total : 10.8 kg		12 pcs
Product:	15.7 x 11.81 x 3.54"	N.W.:	1.80 lbs
Carton:	T.W: 23.81 lbs		12 pcs

= Each bag saves the equivalent of the number of plastic bottles indicated

= Chaque sac permet d'économiser l'équivalent du nombre de bouteilles plastiques indiqué



EVE
Design by Luca Artioli



TERA
Design by Luca Artioli



LC2200 EVE BACKPACK



Passant pour trolley
Loop for trolley



Poche isotherme
Cooler pocket



Poche pour mobile
Mobile phone pouch



Dos renforcé - Ouverture au dos
Reinforced back - Backside opening



Poche Power bank avec œillet pour câble
Power bank pouch with eyelet for USB cable

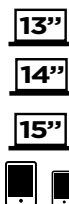

Sac à dos anti-vol - Compartiments pour ordinateur jusqu'à 15" et tablettes - Ouverture au dos - Pochette pour power bank avec passage pour fil et prise USB - Capacité : 22 L
Anti-theft backpack - Compatible up to 15" laptop and tablet compartments - Back side opening - Power bank pocket with wire space and USB plug - Capacity: 22 L

Produit :	30 x 18,5 x 40 cm	P. Net :	670 gr
Carton :	P. Total : 8 kg		12 pcs
Product:	11,8 x 7,28 x 15,7"	N.W.:	1,47 lbs
Carton:	T.W. : 17,63 lbs		12pcs



LC2600 BACKPACK



Sac à dos - Poignée latérale - Compartiment pour ordinateur 15" - Dos renforcé - Multi poches - Capacité: 16 L
Backpack - Side handle - 15" laptop compartments - Reinforced back - Multi pockets - Capacity: 16 L

Produit :	30 x 13 x 43 cm	P. Net :	790 gr
Carton :	P. Total : 8.4 kg		12 pcs
Product:	11,8 x 5,1 x 16,9"	N.W.:	1,74 lbs
Carton:	T.W. : 18,51 lbs		12 pcs

LC2601 MESSENGER BAG



Sac messenger - Compartiment pour ordinateur 15" - Dos renforcé - Multi poches - Capacité: 19 L
Messenger bag - 15" laptop compartment - Reinforced back - Multi pockets - Capacity: 19 L

Produit :	40 x 18 x 27 cm	P. Net :	700 gr
Carton :	P. Total : 7,4 kg		12 pcs
Product:	15,7 x 7,08 x 10,6"	N.W.:	1,54 lbs
Carton:	T.W. : 16,31 lbs		12 pcs

LC2602 GYM BAG



Sac à dos double compartiments - Usage sport et business - Compartiments ordinateur 15" et tablettes - Dos renforcé - Multi poches - Capacité: 23 L
Double compartment backpack - For sport and business - 15" laptop and tablet compartments - Reinforced back - Multi pockets - Capacity: 23 L

Produit :	30 x 17 x 45 cm	P. Net :	900 gr
Carton :	P. Total : 10.4 kg		12 pcs
Product:	11,8 x 6,7 x 17,7"	N.W.:	2 lbs
Carton:	T.W. : 22,93 lbs		12 pcs

LC2603 ORGANIZER POUCH



Pochette renforcée pour accessoires électroniques - Ouverture à plat
Reinforced pouch for electronic accessories - Flat opening

Produit :	25 x 7 x 14 cm	P. Net :	130 gr
Carton :	P. Total : 8,2 kg		48 pcs
Product:	9,9 x 2,8 x 5,5"	N.W.:	0,29 lbs
Carton:	T.W. : 18,08 lbs		48 pcs

= Each bag saves the equivalent of the number of plastic bottles indicated

= Chaque sac permet d'économiser l'équivalent du nombre de bouteilles plastiques indiqué

PEANUT

Design by Luca Artioli



PACKABLE

Design by Margherita Matticari & Luca Artioli



LN1510 PEANUT BACKPACK



- X
- B
- K
- TR
- BG
- PR
- Y



B K TR



BG PR Y

Sac à dos repliable en pochette compacte -
Capacité : 18 L
Foldable backpack in a pouch - Capacity: 18 L

Produit : Backpack: 31 x 14 x 43 cm	P. Net : 260 gr
Foldable in pouch: 14 x 2.5 x 24 cm	
Carton : 49 x 46 x 26 cm	P. Total : 12.6 kg 48 pcs

Product: Backpack: 12.2 x 5.5 x 16.9"	N.W: 0.57 lbs
Foldable in pouch: 5.5 x 0.98 x 9.4"	
Carton: 19.29 x 18.11 x 10.2"	T.W: 27.78 lbs 48 pcs

LN1513 PEANUT DUFFLE BAG



- X
- B
- K

Sac de voyage repliable en pochette compacte -
Capacité : 54 L
Travel bag foldable in a pouch - Capacity: 54 L

Produit : Gym bag: 44 x 21 x 30 cm	P. Net : 320 gr
Foldable in pouch: 24 x 6 x 14 cm	
Carton : 52 x 46 x 30 cm	P. Total : 15.3 kg 48 pcs

Product: Gym bag: 17.3 x 8.3 x 11.8"	N.W: 0.76 lbs
Foldable in pouch: 9.44 x 2.36 x 5.51"	
Carton: 19.29 x 18.11 x 10.2"	T.W: 33.73 lbs 48 pcs

LN1512 PEANUT GYM BAG



- X
- B
- K
- TR
- BG
- PR
- Y

Sac de gym repliable en pochette compacte -
Capacité : 27 L
Gym bag foldable in a pouch - Capacity: 27 L

Produit : Travel bag: 57.5 x 30 x 35 cm	P. Net : 430 gr
Foldable in pouch: 27 x 6 x 14 cm	
Carton : 55 x 48 x 44 cm	P. Total : 20.6 kg 48 pcs

Product: Travel bag: 22.6 x 11.8 x 13.8"	N.W: 0.94 lbs
Foldable in pouch: 10.62 x 2.36 x 5.51"	
Carton: 21.65 x 18.89 x 17.32"	T.W: 45.41 lbs 48 pcs



NC N B K BG

LC2310 PACKABLE DUFFLE

Design by Margherita Matticari



- NC
- N
- B
- K
- BG

Sac de voyage cylindrique repliable en
pochette compacte - Capacité : 21 L
Foldable duffle bag - Capacity: 21 L



Produit : Backpack: 29 x 13 x 41 cm	
Foldable in pouch: 15 x 1.4 x 18.5 cm	
P. Net : 305 gr	
Carton : 58,5 x 30,5 x 40 cm	
P. Total : 12.8 kg 40 pcs	

Product: Backpack: 11.4 x 5.2 x 16.1"	
Foldable in pouch: 5.9 x 0.5 x 7.2"	
N.W: 0.67 lbs	
Carton: 23.62 x 12.59 x 15.75"	
T.W: 28.22 lbs 40 pcs	

LC2311 PACKABLE BACKPACK

Design by Luca Artioli



- NC
- N
- B
- K
- BG

Sac à dos repliable en pochette
compacte - Capacité : 15 L
Foldable backpack - Capacity: 15 L



Plié en pochette
Foldable in pouch

Produit : Duffle bag: Ø20.5 x 50 cm	
Foldable in pouch: Ø20.5 x 1.4 cm	
P. Net : 170 gr	
Carton : 43 x 35,5 x 43 cm	
P. Total : 9.9 kg 48 pcs	

Product: Duffle bag: Ø8 x 19.6"	
Foldable in pouch: Ø8 x 0.5"	
N.W: 0.37 lbs	
Carton: 17.32 x 14.96 x 17.32"	
T.W: 21.82 lbs 48 pcs	

LEXON can make this collection with rPET on special request, please check minimum order quantity with our sales team
LEXON peut concevoir cette collection avec des matériaux rPET, merci de vérifier le minimum de commande avec notre équipe commerciale

= Each bag saves the equivalent of the number of plastic bottles indicated
 = Chaque sac permet d'économiser l'équivalent du nombre de bouteilles plastiques indiqué

LL114 NEO LUGGAGE TAG

Design by Kazuya Koike



X7

A7

DB

R

Étiquette bagage avec lanière en gomme

Matériaux : aluminium / gomme

Marquage conseillé : sérigraphie - laser

Luggage tag with rubber string

Material: aluminium / rubber

Suggested branding: silkscreen - laser

Produit :	3,3 x 0,7 x 8,8 cm	P. Net :	45 gr
Carton :	P. Total : 4,5 kg		160 pcs

Product:	1.3 x 0.3 x 3.5"	N.W.:	0.1 lbs
Carton:	T.W.: 9.92 lbs		160 pcs



CUSTOMIZE YOUR LEXON BAG

PERSONNALISEZ VOTRE SAC LEXON

Discover our range of over-plates* customizable with your logo on request when placing your order.

Découvrez notre gamme de sur-plaques* personnalisables avec votre logo sur demande à la commande.



*Patented system / Système breveté

ONE+



31mm x 19mm
1.2 x 0.7"

PREMIUM+



33 x 18 mm
1,3 x 0,7"

TRACK



32 mm x 13 mm
1.2 x 0.5"

CHALLENGER



60 mm x 9 mm
2.4 x 0.4"

EVE



Ø 37 mm
Ø 1.4"

TERA



40 x 31,5 mm
1,6 x 1,2»

PEANUT



44 mm x 34 mm
1.7 x 1.3"

PACKABLE



Ø 28 mm
Ø 1.1"

Additional branding techniques available for bags:

- Silkscreen on fabric
- Digital printing

Autres techniques de marquage disponibles pour la bagagerie:

- Sérigraphie sur tissu
- Impression numérique

MATERIALS
MATÉRIAUX



ANODIZED ALUMINUM

LA125 MINO+



LA129 MINO+ L



LA131 TAMO



LL134 WINO



LH89 ROMINO



LD149 MUSO



LR154 MINUT



LR152 FLIP PREMIUM



LR155 RAY CLOCK



LA132 RAY SPEAKER



LH101 RAY LIGHT



LR156 CONIC CLOCK



LA133 CONIC SPEAKER



LH60 MINA



LH64 MINA M



LH65 MINA L



LH76 MINA L AUDIO



LR153 MINA SUNRISE



LH96 LUMA S



LH87 LUMA M



LH97 LUMA L



LH98 LUMA XL



LH95 STELI



LI104 NOVA S



LI105 NOVA M



LI106 NOVA L



LH107 STELI LOUNGE



LH110 STELI CANDLE



LH70 BUBBLE LAMP



LH99 MIMI



LA134 TERRACE+



LS64 SCRIBALU



LL129 FINE BAG LIGHT 2



LL130 FINE TUBE POWER BANK 2



LL147 NOMADAY UV STRAW



LD144 NOMADAY CARD



LD135 CITY RULER

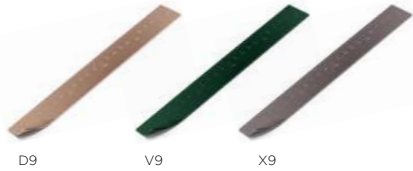

LD138 CITY DESK TRAY



LL157 NOMADAY PILLBOX



LD137 CITY CARD STAND



LD14 CARD BOX

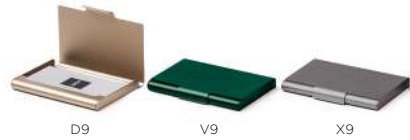

LL128 NOMADAY LOCK



LD139 CITY TAPE DISPENSER



LD140 CITY PEN CUP



LL138 NOMADAY POWER BANK



LL158 METALI-C



LL136 NOMADAY LIGHT



LL137 NOMADAY FLASH



LH77 HORIZON HANGING LAMP



LH78 HORIZON SAFETOUCH



LL148 HORIZON THERMO BOTTLE



LH85 HORIZON DIFFUSER



LH91 HORIZON DISPENSER



GLOSSY

LA125 MINO+



LA124 MINO T



LH60 MINA



LH64 MINA M



LH65 MINA L



LS101 C-PEN



LS102 C-PEN STYLUS



LH88 ORBE



LH105 STELI S



COLORS

LR157 FLIP CLASSIC



LR158 FLIP MINI



LA123 MINO S



LA124 MINO T



LA120 MINO X



LA119 TYKHO 3



LD150 PEAS HUB C



LU21 MINI HOOK UMBRELLA



SYNTHETIC LEATHER

LA127 **SPEAKERBUDS**



LL153 **SOFTPOWER MAGBANK**



LL142 **SOFTPOWER WIRELESSBANK**



LA128 **POWERSOUND**

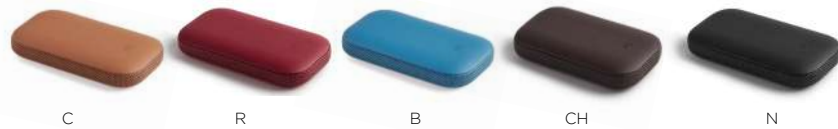

LL141 **OSLO ENERGY+**



LL152 **POWERON**



LD151 **POWERUP**



LA130 **OSLO NEWS PREMIUM**



LD145 **CITY ENERGY PRO**



LH94 **LANTERN**



WOOD

LH39 **ZEN CUP**



W8

LH40 **ZEN LARGE CUP**



W8

LH42 **ZEN COTTON BOX**



W8

LH43 **ZEN TISSUE BOX**



W8

CLASSIC / BASIC COLORS

LL121 LUCIE

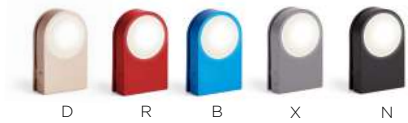

LH63 BOLLA+



LH79 MANO



LH59 OBLIO



LH69 OBLIO BOX



SALES & MERCHANDISING TOOLS

SUPPORTS D'AIDE À LA VENTE

With our range of displays, enhance the presentation of our Lexon products in your store.
We offer solutions tailored to the size and style of your retail space.

*Avec notre gamme de displays, sublimes la présentation de nos produits Lexon dans votre magasin.
Nous proposons des solutions adaptées à la taille et au style de votre espace de vente.*

ACRYLIC DISPLAYS PRÉSENTOIRS EN ACRYLIQUE



LAD105
6 x MINO+



LAD106
12 x MINO+



LAD111
MINO+ / TWIN MINO+
MINO X / MINO L / MINO T



LAD107
MINO T



LAD108
4 x MINO X



LAD112
MINO+ / MINA M



LAD77
4 x MINA



LAD78
8 x MINA



LAD39B
3 x TYKHO 3



LAD48
6 x FLIP CLASSIC



LAD64
6 x FLIP MINI



LAD31B
DISPLAY FOR BAGS



LAD76
LEXON BLOCK MARK



LAD129 TO LAD146
PRODUCT BLOCK MARK

CARDBOARD DISPLAYS CHEVALETS EN CARTON



297 x 210 mm

LAD88
MINA



297 x 210 mm

LAD94
MINO X



297 x 210 mm

LAD99
TYKHO 3

COUNTER DISPLAYS* PLV DE COMPTOIR*



495 x 300 x 300 mm

WOODEN FURNITURE* MOBILIER EN BOIS*



81 x 81 x 118 cm

*on order only / sur commande uniquement

COLLABS SALES & MERCHANDISING TOOLS

COLLABORATIONS SUPPORTS D'AIDE À LA VENTE

Promote this exciting collaboration in store with a dedicated POS counter display pre-loaded with a selection of collab units.

Faites la promotion de cette collaboration en magasin grâce à notre PLV de comptoir préremplie avec les pièces de nos collaborations.

POS COUNTER - THE FAMILY

PLV DE COMPTOIR - FAMILLE

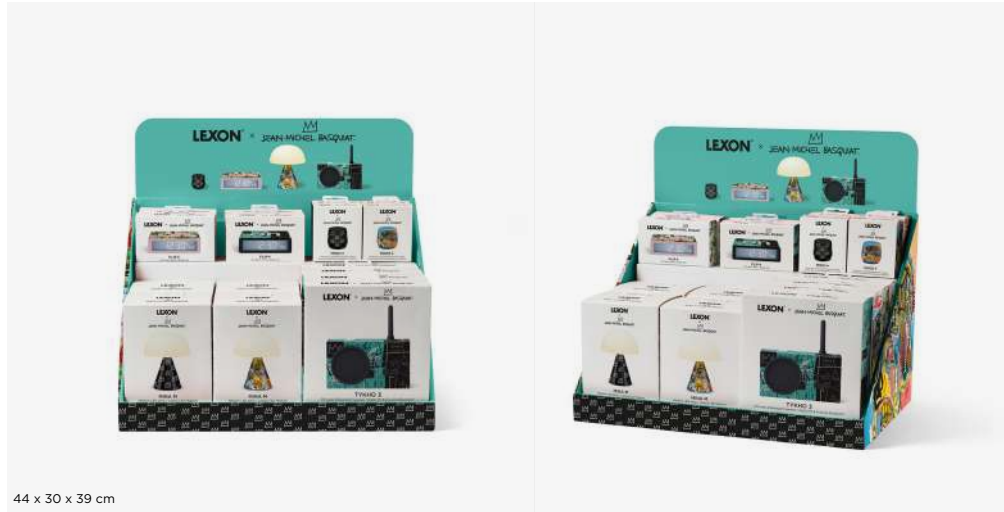

44 x 30 x 39 cm

LBBSQ01-COUNTER
4 PRODUCTS / 24 UNITS



44 x 30 x 39 cm

LBKH1-COUNTER
4 PRODUCTS / 24 UNITS

POS COUNTERS - THE FAMILY

PLV DE COMPTOIR - FAMILLE



31,8 x 31,2 x 48,6 cm

LBPT01-COUNTER
4 PRODUCTS / 2 PCS X 6 COLORS / 48 UNITS

THE MONOCHROME

MONOCHROME

THE ORBE

ORBE



54,4 x 58,5 x 34,5 cm

LBPT03-COUNTER-R
4 PRODUCTS / 6 PCS X 1 COLOR / 24 UNITS



54,4 x 58,5 x 34,5 cm

LBPT02-COUNTER
1 PRODUCT / 2 PCS X 6 COLORS / 12 UNITS

CORPORATE GIFTS

CADEAUX D'AFFAIRE

We design, develop and manufacture corporate gift objects to serve the needs of leading companies and brands.

Nous concevons, développons et fabriquons des cadeaux d'affaire pour répondre aux besoins des grandes entreprises et des marques.



EQUIP YOUR TEAM
ÉQUIPEZ VOS COLLABORATEURS



PROMOTE YOUR BUSINESS
FAITES LA PROMOTION DE VOTRE ENTREPRISE



REWARD YOUR STAFF
RÉCOMPENSEZ VOTRE ÉQUIPE

BRANDING TECHNIQUES

TECHNIQUES DE PERSONNALISATION



SILKSCREEN
SÉRIGRAPHIE



LASER
LASER



LASER ON PLATE
LASER SUR PLAQUE



GEL INK
ENCRE GEL



PAD INK
TAMPOGRAPHIE



DIGITAL PRINTING
IMPRESSION DIGITALE

YOUR PROJECT

VOTRE PROJET

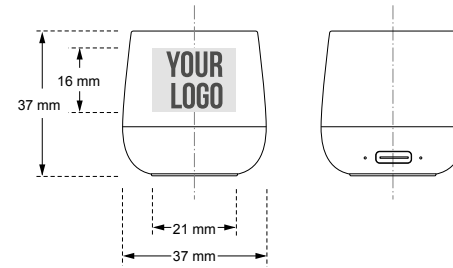

BRANDING ON PRODUCT*
PERSONNALISATION DU PRODUIT*



BRANDING ON PACKAGING**
PERSONNALISATION DU PACKAGING**

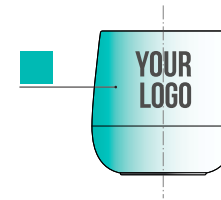

SPECIAL COLOR DEVELOPMENT***

DÉVELOPPEMENT D'UNE COULEUR PERSONNALISÉE***

*50 pcs / **3000 pcs / ***5000 pcs



SPECIAL KIT CREATION

CRÉATION DE KIT THÉMATIQUE

THEY TRUST US

ILS NOUS FONT CONFIANCE

SAINT LAURENT
PARIS

KENZO

AIRBUS

AUDEMARS PIGUET
Le Brassus

ZARA
HOME



LEXON®

Maison de design *française*

Since its creation in 1991, Lexon has relentlessly pushed the limits and created a difference in the world of design while remaining true to its commitment to make small objects useful, beautiful, innovative and affordable. Whether in electronics, audio, office, leisure and travel accessories, Lexon has established a special relationship with creativity and partnered with the best designers around the world to create timeless collections of lifestyle products. Today, with more than 35 years of existence, more than 250 awards, collaboration with some of the most renowned designers, a retail presence in more than 90 countries across the Globe, Lexon has truly established itself as a worldly-known French design brand.



BOW GROUP

BOW Group with its **4 offices around the world** - Paris, Geneva, Miami and Shenzhen - is a **global player and multi-skilled platform** with design, development, manufacturing and distribution capabilities, which offers solutions answering the needs of our modern lifestyles. With more than 2 million pieces sold every year, BOW aims to become **a world leader in lifestyle products and accessories in all their forms**: connected, design, art; with its **two consumers brands Lexon and MyKronoz**, its **two retail concepts** that are **Legacy** and **Musart**, as well as **BOW Industries**, its **R&D center** that owns 70 design patents.

MYKRONOZ

CONNECTED OBJECTS

Founded in 2013, MyKronoz focuses on consumer IoT with a wide portfolio spanning from wearables, mainly with activity trackers and hybrid watches, as well as smart products for the home. To date, our Swiss brand has sold 3M of connected devices with its own cloud architecture and proprietary mobile app. Over the past three years, MyKronoz has won 3 Red Dot Design Awards and 2 IF Design Awards, proving its expertise in designing smart objects and meaningful experiences that enhance people's lives.



mykronoz.com

MUSART

ART OBJECTS

Musart is a fast-growing art marketplace to buy original artworks and licensed products. Since its inception in 2014, the mission of this online destination is to make art accessible, giving anyone the opportunity to own a piece of museum. Partnerships with world-class institutions and cultural organizations allow Musart to bring not only exclusive and authentic items, but also, to honor iconic artists.

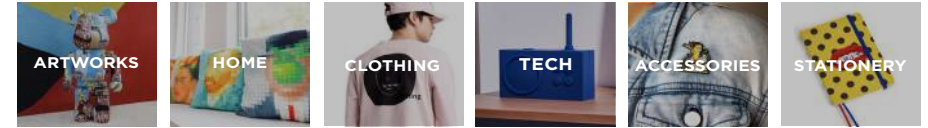

musart.com

LEGACY

LUXURY OBJECTS

Legacy is an exclusive hybrid concept store boasting a sharply curated selection of products comprising multiple categories such as watches, jewelry, art, tech, books, eyewear, beauty and more. We work both with well-established brands and young emerging talents to offer a unique selection of exceptional items and creations.

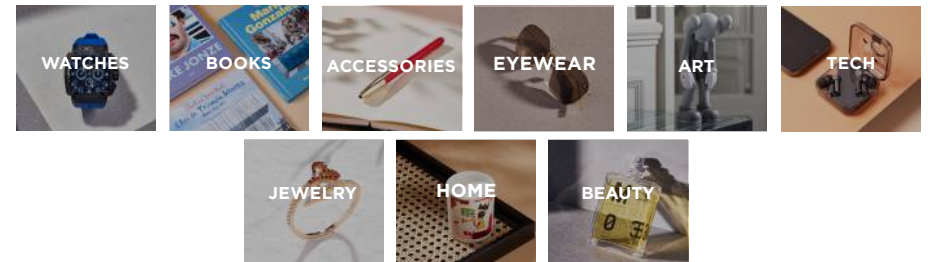

store-legacy.com

